



URBAN STREET DESIGN GUIDELINES PUNE



Urban Street Design Guidelines

Pune



URBAN STREET DESIGN GUIDELINES,PUNE

PUNE MUNICIPAL CORPORATION



PMC'S USDG TEAM

Mr. Pramod Nirbhavne (ACE, Road Dept. PMC)
Mr. Rajendra Raut (CE, Road Dept. PMC)
Dr. Pravin Ashtikar (J.M.D, PMPML, Pune)
Mr. Vishwas Pandhare (DCP Traffic, Pune)
Mr. Yuvraj Deshmukh, Mr. Tandale, Mr. Gone and Mr. Shevte (PMC Road Dept.)
Mr. Ranjit Gadgil and Mr. Sujit Patwardhan (Parisar)

PRINCIPAL CONTRIBUTORS

Mr. Prashant Inamdar (Pedestrians First)
Ms Pranjali Deshpande (ITDP)
Ms Apoorva Mahajan (ITDP)



पादचारी प्रथम
Pedestrians FIRST

CONSULTANTS

VK:a architecture



TEAM

Ar. Nikhil Mijar
Ar. Anuja Gokhale
Ar. Dwaipayan Chakravarty
Ar. Rutuja Bhosale

ADVISORS

Ar. Hrishikesh Kulkarni
Ar. Poorva Keskar
Ar. Anagha Paranjape - Purohit
Ms. Apoorva Kulkarni



Orangetree

PUBLIC OUTREACH PARTNERS

SUSTAINABILITY INITIATIVES TRUST

TEAM

Ms. Shraddha Zende
Ms. Apeksha Patil

PHOTOGRAPHER

Praful Ninale

Foreword



It gives me great pleasure to introduce '**Urban street design guidelines for Pune**' as a new policy document which puts place and people before the movement of vehicles. It emphasizes on the concept of 'equitable allocation of street space' which is also one of the key principles outlined in the National Urban Transport Policy.

The Urban Street Design Guidelines give an overview of various elements that go into designing streets making them universally accessible, and also provide standard templates for different sizes and uses of streets.

This document provides a mandate for PMC engineers and planners for designing and executing streets to meet local needs, avoiding a one-size-fits-all approach. We cannot turn the clock back but by implementing the recommendations mentioned here, we can make sure that in future, we design streets which put people and the quality of their lives first.

The document is also for reference to architects, urban planners, local communities and NGOs in Pune so that they can be more involved in decisions about changing the character of streets in Pune and making them more people-friendly.

Pune Municipal Corporation is committed to an agenda of sustainable development of the city and good street designs are of critical importance in this effort. These guidelines represent a step change in established practices and given the direct influence that streets can have in our lives and environment, I believe it to be an essential change.

Kunal Kumar,
Municipal commissioner
Pune

Contents

01 INTRODUCTION

Vision and goals of USDG, Applicability, Implementation of USDG, Scope of Guidelines, Transportation studies and legislation in India and Pune

1

06 UNIVERSAL ACCESSIBILITY AND BARRIER FREE DESIGN ELEMENTS

Fundamentals, Design Requirements, Footpath design, Paving block and warning blocks, Curb ramp and slope ramp, intersection and crossings, Traffic signal, signage and street furniture

38

02 STREET TYPOLOGY

Proposed street hierarchy for Pune, Principles of street design, Street Elements

4

07 INTERSECTION

Planning of intersection, Design of intersection, Intersection design for pedestrians, Intersection design for cyclists, Intersection design for vehicles, compact intersections

44

03 STREET ELEMENTS

Footpath, Cycle tracks, Carriageway, Shoulders, On- street parking, BRT lanes and Bus stops

7

08 USDG REFERENCE TEMPLATES

Street cross sections and plans based on RoW, Plans for intersections

49

04 SAFETY ELEMENTS

Pedestrian Crossings, Traffic calming Measures, Speed breakers, Traffic signals, Central medians, Railings and bollards, Street lights, Street furniture, Signage, Road markings, Advertisements

16

09 STREET DESIGN PROCESS

Road inventory, surveys, setting vision, referring USDG templates, actual design and integration of existing elements, right of way overlay, stakeholder consultation

102

05 MULTI UTILITY ZONES

Street plantation, Utility services, Storm water, Garbage bins, Public toilets

30

Contents (Street element wise)

PEDESTRIAN RELATED ELEMENTS

1.Footpath.....	07
2.Railings.....	19
3.Bollards.....	20
4.Universal accessibility for footpaths.....	40
5.At grade pedestrian crossing.....	16
6.Mid block crossing.....	17
7.Pedestrian refuge island.....	17
8.Grade separated pedestrian crossings.....	17
9.Pedestrian Signals.....	28
10.Universal accessibility- Tactile paving.....	40
11.Universal accessibility-Curb ramp and slope ramp.....	41
12.Universal design for pedestrian grade separators.....	42

CYCLE RELATED ELEMENTS

1.Cycle track.....	09
2.Intersection design for cyclists.....	46
3.Cycle box.....	46
4.Merging -demerging cycle lane.....	46
5.Paint marking cycle priority lane.....	46

ROAD SIDE ELEMENTS

1.Multi utility zone (MUZ).....	30
2.Bus stops.....	11
3.Street lights.....	21
4.Tree plantation.....	31
5.Hoardings, Advertisements.....	27
6.On street parking.....	14
7.Parking bay design.....	14
8.Auto rickshaw stands.....	14
9.Utilities and services.....	35
10.Storm water management.....	36

11.Street furniture.....	23
12.Garbage containers.....	37
13.Public toilet.....	37
14.Universal design for street furniture and street signage.....	43

CARRIAGEWAY ELEMENTS

1.Carriageway design.....	13
2.Shoulders.....	13
3.Road markings.....	25
4.Traffic signage.....	24
5.Traffic signals.....	29
6.Universal design for traffic signal.....	42
7.Medians.....	19
8.BRT lanes.....	12
9.Traffic calming measures.....	18
10.Speed breakers.....	21

INTERSECTIONS

1.Curb extensions.....	45
2.Turning radius.....	45
3.Channeliser.....	45
4.Roundabouts.....	48
5.Tight turns.....	48
6.Universal accessibility for intersection and crossing.....	42

Executive Summary

The National Urban Transport Policy (NUTP) has been formulated by the Ministry of Urban Development in 2006 to transform the current urban transport system into a safe, convenient and efficient transportation system across all urban areas in India. It has set the national guidelines for action framework for urban transport in cities.

Various studies and projects like Comprehensive Mobility Plan, DMRC Metro Report, Hawkers policy, BRTS in the field of traffic and transportation have been undertaken by the Pune Municipal Corporation to achieve the objectives of NUTP.

Preparation of Urban Street Design Guidelines is also one of the tasks identified by the authority in this regard. Similar efforts have been taken by Delhi, Bangalore and Ahmedabad planning authorities.

The objective of these guidelines is defining and initiating a process to ensure that appropriate street types and street design elements are implemented to create better streets to support transportation objectives for the city considering the present and future needs.

'If we can develop and design streets so that they are wonderful fulfilling places to be community- building places, attractive public places for all people of cities and neighbourhood , then we will have successfully designed about one third of the city directly and will have had an immense impact on the rest.'

-'Great streets' Allan Jacob



**Streets form the nervous system of the city.
The health of the city and its inhabitants is dependent on its streets.**

INTRODUCTION

Describes the background for having these guidelines and the process followed for preparation of this document.

Introduction

VISION

To re-establish streets as experiential public spaces that offer citizens to use all modes of transport, including walking with safe and dependable commuting experience.

GOALS

To create design guidelines for streets in Pune which prioritize streets for people and not for vehicles, thereby reinstating the position of streets of Pune as dominant and most vibrant urban public realm.

To integrate functional requirements of all road users and stakeholders in the street design as per priority, suitability and need of each road user, ensuring that there is equitable allocation of available road space across all stakeholders.

To design and develop streets for safety of all road users.

Purpose of USDG

The purpose of USDG is to provide mechanism for establishing the street system which will accommodate growth, provide transportation choices and keep the city liveable. Such a system shall provide 'complete' streets which will serve all users giving optimum priorities to every user group. USDG intends to provide a process which distinctly, systematically and comprehensively considers the needs of the motorized and non motorised users when planning and designing streets.

USDG shall supplement the existing policy, legal and technical effort to achieve improved results in maintaining consistently better streets within the city. It establishes a common reference point for all those involved in the design of urban streets so as to have effective collaboration amongst various agencies and all the stakeholders to address the issues related to traffic and transportation.

It presents guidance on how to do things differently within the existing policy, technical and legal framework. It is designed to be a flexible document that can be altered and improved to incorporate new treatments as appropriate after testing to address the need of time.

'Even assuming that physical characteristics of the street are not important criteria for deciding what makes one street better than the other, one presumably wants to do ones best to design and arrange the pieces in ways that will be better, that are more likely to please, uplift, attract or achieve a desired set of values than some other arrangement.'

--'Great streets' by Allan Jacob

Applicability of USDG

USDG is applicable to all the street stretches within the jurisdiction of PMC. These include all the existing roads, proposed new roads and the road stretches proposed to be widened within the existing PMC city limit as well as all those within the extended or future boundaries of PMC.

Implementation of USDG

USDG is directed to all such organizations and professionals who are associated with the planning, design, construction, approval and maintenance of existing and new streets within the jurisdiction of PMC. All such professionals and departments of the urban local body responsible for design, construction, maintenance and approval of the various street elements considered in this manual should adhere to the guidelines and recommendations mentioned for the respective works. Local communities, activist groups, NGOs working in any field related to traffic and transportation for the city and all relevant stakeholders are to be encouraged to refer this document.

Scope of Guidelines

This manual gives guidelines purely regarding the designing of a street for appropriate allocation of spaces and general design specifications for various elements of the street. It is recommended to refer to the IRC/STAC report of the PMC for technical engineering aspects as regards, material, technology and construction procedure.

Transportation studies and legislation in India and Pune

Following are some of the acts, laws and initiatives undertaken until now by Central and State Government regarding the road and transportation sector prominently related to vehicles, road construction, road users. USDG has taken into consideration the information and suggestions as mentioned in these studies.

➤ Indian Road Congress Guidelines

The Indian Roads Congress (IRC) was set up by the Government of India in consultation with the State Governments in December, 1934 and is a registered society under the Registration of Society Act. It is the premier body of Highways Engineers in India. The Principal objectives of the India Roads Congress are to provide a national forum for regular pooling of experience and ideas on all matters concerned with the construction and maintenance of highways, to recommend standard specifications and to provide a platform for the expression of professional opinion on matters relating to roads and road transport including those of organizations and administration. It also publishes Journals, monthly magazines and research bulletins.

Few of such journals regarding design of urban roads have been considered in the study for USDG. USDG recommends to follow the relevant IRC for the technical specifications and details for construction of street elements.

➤ **Motor vehicles Act**

The Motor Vehicles Act, 1988 is an Act of the Parliament of India which regulates all aspects of road transport vehicles. The Act came into force from 1 July 1989. It replaced Motor Vehicles Act, 1939 which earlier replaced the first such enactment Motor Vehicles Act, 1914. The Act provides in detail the legislative provisions regarding licensing of drivers/conductors, registration of motor vehicles, control of motor vehicles through permits, special provisions relating to state transport undertakings, traffic regulation, insurance, liability, offences and penalties, etc.

➤ **Disabilities Act**

The Persons with Disabilities (Equal Opportunities, Protection of Rights and Full Participation) Act of 1995 has been on the statute book for nearly 20 years. This Act has been the basis of a largely empowering jurisprudence on the Rights of Persons with Disabilities.

India has ratified the UN Convention on the Rights of Persons with Disabilities (UN CRPD) and has undertaken the obligation to ensure and promote the full realization of all human rights and fundamental freedoms for all Persons with Disabilities without discrimination of any kind on the basis of disability. In fulfillment of this international commitment, the country is obligated to enact suitable legislation in furtherance of the rights recognized in the UN Convention.

Accessibility is one of the rights that is given importance under this act which makes it mandatory to provide for disabled friendly design of public places including roads and streets.

➤ **The Guidelines and Toolkits for Urban Transport Development**

The Guidelines and Toolkits for Urban Transport Development were prepared by a Technical Assistance on Urban Transport Strategy (TA 4836-IND) funded by the Asian Development Bank for the Ministry of Urban Development (MoUD), Government of India. These documents are designed to help decision makers and practitioners in states and municipal governments who are concerned with urban transport development in medium-sized cities in India.

It consists of 5 modules addressing topics like -

- Comprehensive mobility plans
- Bus Rapid Transit Systems (BRTS)
- Guidelines for Bus service improvement
- Guidelines for parking measure
- Guidelines for NMT measures.

➤ **The National Urban Transport Policy (April 2006)**

It was approved by GOI to tackle urban mobility issues to ensure a safe and sustainable urban mobility in the coming decades. It provides for integrated land use and transport plans in cities, coordinated planning for urban transport, people oriented equitable allocation of road space, capital support in the form of equity participation and or viability gap funding, innovative financing, dedicated urban transport funds, non-motorised transport, car restraint measures, clean fuel and vehicle technology, private sector participation and pilot projects in cities to establish models of best practices.

➤ **Recommendations of working group on 12th FYP**

The Working Group on Urban Transport for the 12th Five Year Plan has made recommendations on investments and plans on 9 broad themes in urban transport which were identified in line with the National Urban Transport Policy (NUTP) developed by the Government of India.

➤ **Study on traffic and transportation policies and strategies in Urban Areas in India ,MOUD, 2008**

The study aimed at updating the transportation information and projections made from the previous study 'Traffic and transportation policies and strategies in Urban Areas in India 1994' in order to review the National Urban Transport Policy in light of the new and comprehensive data provided within this report.

➤ **National Mission on sustainable habitats:
Report of the Sub-Committee on Urban Transport**

Under the National Action Plan for Climate Change, the National Mission on Sustainable Habitat has been launched to cover various aspects which include better urban planning and modal shift to public transport. Regarding Urban Transport, the objectives of the National Mission on Sustainable Habitat (NMSH) are “To address the issue of mitigating climate change by taking appropriate action with respect to the transport sector such as evolving integrated land use and transportation plans, achieving a modal shift from private to public mode of transportation, encouraging the use of non-motorised transport, improving fuel efficiency, and encouraging use of alternative fuels etc.

➤ **UTTIPEC Guidelines for street design**

As per the recommendations of National Urban Transport Policy, DDA, Delhi has notified Unified Traffic and Transportation Infrastructure (Plg. & Engg.) Centre (UTTIPEC) to enhance mobility, reduce congestion and to promote traffic safety by adopting standard transport planning practices. Recently UTTIPEC has published street design guidelines to promote sustainable transportation system in the city of Delhi.

➤ **Urban Local Bodies Initiatives**

Following are the policies and studies undertaken by PMC:

- Comprehensive Mobility Plan
- Environmental status report
- City Development Plan
- Pedestrian policy
- Parking policy
- Hawker Policy
- BRTS Operational Plan
- DMRC Metro report
- Ring Road

➤ **Better Streets, Better Cities, ITDP**

A street design manual for Indian cities prepared by ITDP, (a not for profit organization) that discusses design details of various street elements and street sections on 'complete streets' principle.

USDG AIMS TO BRING CHANGE IN CURRENT CONDITION OF STREETS IN PUNE.



Existing situation of streets in Pune

Street typology and street elements for Pune

Establishes street typology for Pune and identifies street elements to be categorized to serve principles of street design.

02

2.1 STREET TYPOLOGY

IRC 69:1977 - Space standards for roads in urban areas states that:

In the interest of efficient road transportation, which effectively serves the various land uses in an urban area and at the same time ensures logical community development, it is desirable to establish network of roads divided into different classifications, each system serving a particular function or purpose. The principle factors to be considered in designating roads into appropriate classifications are mobility, activities and parking requirements. The typology defines the street with specific usage and purpose.

Directive principles of the USDG to achieve 'complete streets'

- Designing streets for people.
- Designing the streets for better mobility, safety and livability of the users.
- Establishing an image of the city by restructuring the streets which form the largest public realm of the city .
- Designing the streets to provide more and better mobility choices.



Arterial/Mobility Corridor



Feeder Corridors



Neighborhood / Local streets

2.2 PROPOSED STREET TYPOLOGY FOR PUNE

Basis for proposed street typology in Pune :

Typology of roads is designed considering the existing traffic pattern and the functions of the streets that evolved over the past years and is not merely based on ROW.

Proposed typology is thus Pune-specific as every type of street may have similar ROW but different functions, different landuse and thus different design requirements.

➤ Mobility corridors

Comprehensive Mobility Plan of Pune establishes one level of typology which is Mobility corridors that are major arterial corridors of the city. They are decided by thorough study of Pune's traffic pattern, connectivity, development and Right of way. These are the roads which cater to about 80% of the traffic and are the main growth corridors. Same has been taken as a base and further categorization is done. This will avoid conflict in two studies and will be simple for application. e.g. Karve road, Satara road, Pune Solapur road

➤ Mobility corridors with NMT preference

Some mobility corridors where pedestrian footfall is more are also expected to be designed with preference to NMT and thus they are purposely categorized as a different typology. Eg. Bajirao road, Shivaji road

➤ Feeder streets

Feeders are second most important roads after mobility corridors. They feed the mobility corridors. They are intermediate between main roads and neighborhood streets. e.g. Bhandarkar Road & Prabhat Road act as feeder connecting Law College Road, S. B. Road and F. C. Road

➤ Neighborhood streets

These are local streets. All streets other than mobility and feeder streets are neighborhood streets. These are mostly narrow access streets which form connectivity between feeder roads and individual properties or residences. It is essential to safeguard the privacy and calmness of these streets.

➤ Through traffic streets

Streets which connect to outer sub urban areas of Pune and streets which mostly carry through traffic and connect to mobility corridors are considered as through traffic streets.

PROPOSED STREET TYPOLOGY FOR PUNE

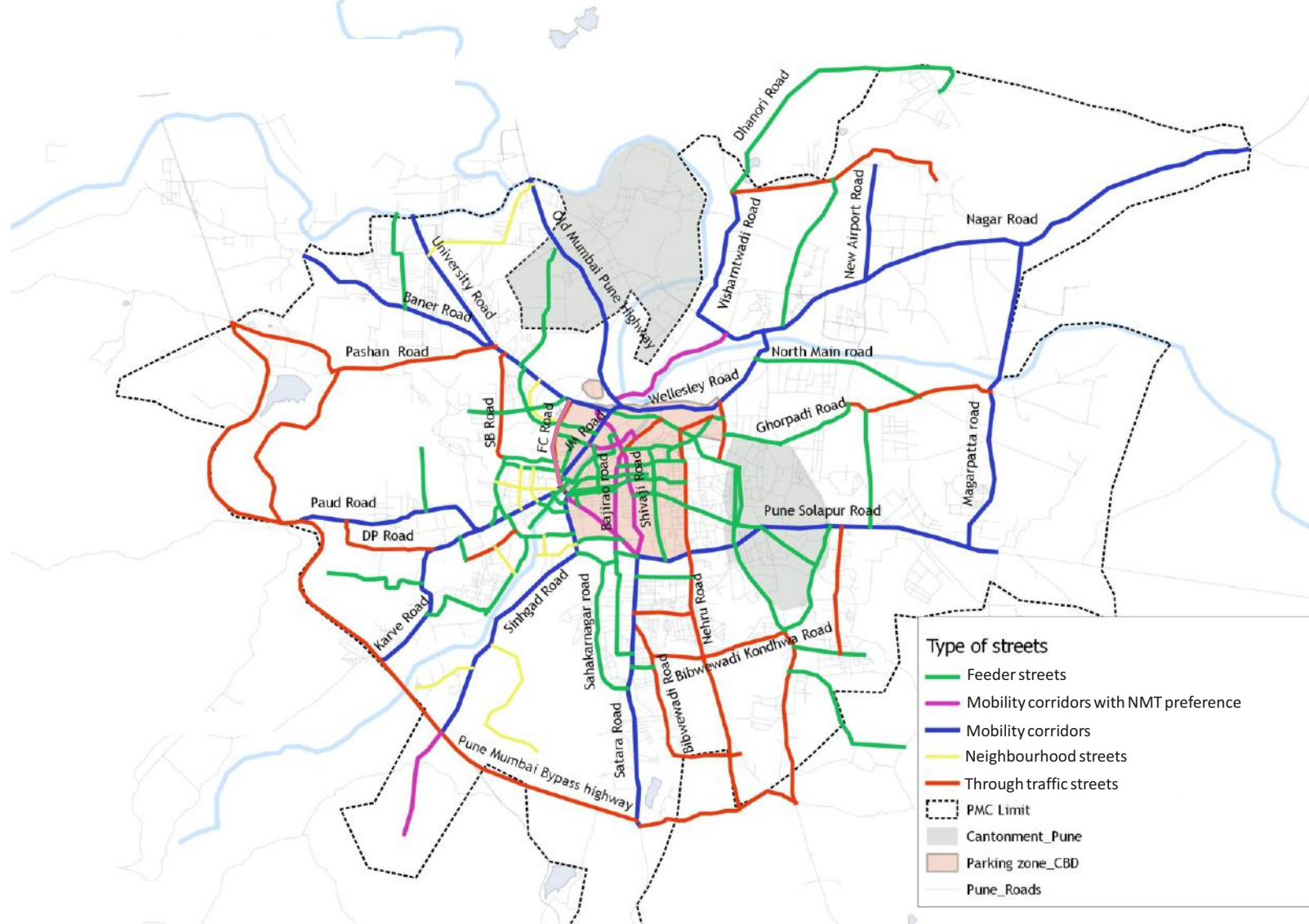

Map of Pune city showing proposed street typology

STREET ELEMENTS

All people should be able to move safely, smoothly and conveniently



- Footpath - clear walkway
- Cycle Track - NMT Lane
- Bus stops
- BRT lanes
- Carriage way - MV lane
- Shoulders
- Parking

Make streets safe, clean, attractive and comfortable for people to walk and drive



- Pedestrian Crossings
- Traffic calming measures
- Speed breakers
- Traffic Signals
- Central Medians
- Railings
- Bollards
- Street lights
- Street furniture
- Signage, markings

Streets to reduce impact on natural and built environment. To have green streets in the city.



- Plantation
- Utility and services
- Storm water management
- Garbage containers
- Public toilet

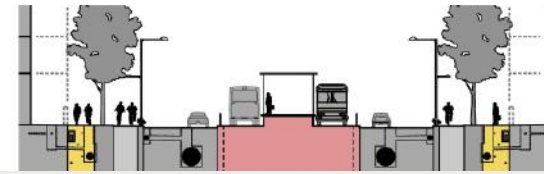

STREET CROSS SECTION

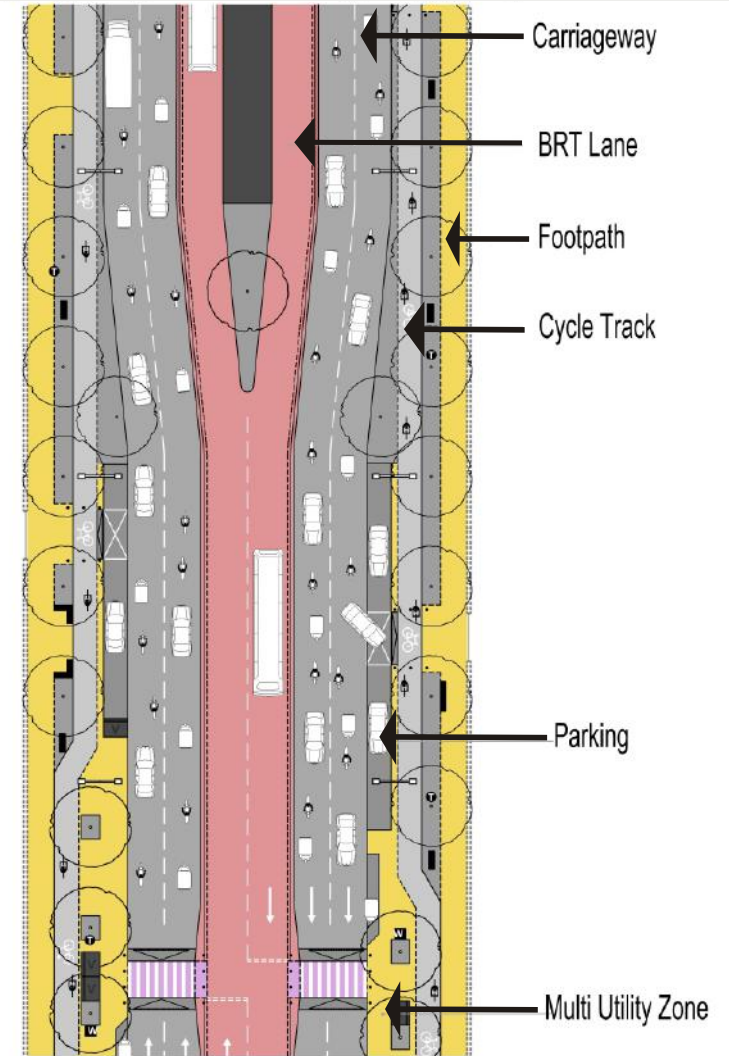

The sketch is only an illustration indicating various street elements and not its technical design'.



- Footpath - clear walkway
- Cycle Track
- Bus stops
- BRT lanes
- Carriage way - MV lane
- Shoulders
- Parking

All people should be able to move safely, smoothly and conveniently

Street elements

Includes introduction to elements, design recommendations based on standards and norms for all such street elements related to mobility aspect.

3.1

FOOTPATH

Introduction

Footpath or sidewalk is a portion of the street reserved only for pedestrians. It is provided on both edges of the street. Footpaths should be walkable, clean and safe for pedestrians and should be free from encroachments, parking and utility obstructions. Good footpaths are the most essential components of any good street in the city.

Clear walking zone of footpath (m)	Max. Number of persons per hour in both directions
1.8	1350
2	1800
2.5	2250
3	2700
3.5	3150
4	3600

Capacity of footpath

(Source: IRC 103-2012 : Guidelines for pedestrian facilities)

Design recommendations

Layout:

- Width of footpaths is to be determined based on the street hierarchy and ROW, land use and pedestrian traffic and as per the universal accessibility design.
- Footpath should provide clear and unobstructed minimum walking zone of 2m horizontally with 2.4m vertical clearance.

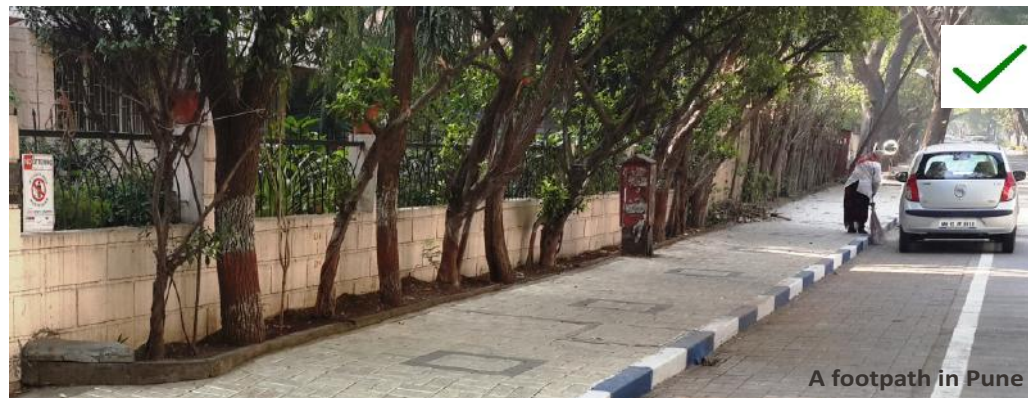

Attributes of good footpath design include:

- Accessibility by all users.
- Continuity and connectivity.
- Adjoining landscaping to create a buffer space between pedestrians and vehicles and also provide shade.
- Adjoining social space (area where pedestrians can safely participate in public life).

- In order to achieve min. 2m clear width of unobstructed walking zone, all such elements like trees, street lights and street furniture etc should be accommodated within MUZ (Multi utility zone) wherever provided. Refer chapter no. 5 for more details on MUZ.
 - Footpath should have guiding blocks and curb ramps for better accessibility to all. Refer chapter no. 6 for more details.
 - In case of obstructions that cannot be removed, footpath width should be suitably increased in that portion to ensure minimum clear width of walking zone. Appropriate markings on road, cats eyes, signages should be provided for road safety.
 - The entire width of footpath is never available for walking. At the side where there are shops, buildings, fence/compound wall etc. certain portion known as 'dead width' or 'frontage zone' is not available for pedestrians. Similarly on the roadside edge of the footpath, certain portion from the edge known as 'edge zone' is not practically useful for walking. Frontage zone should be considered at least 1 m for shopping areas and 0.5 m for non shopping areas with buildings or fence. The edge zone should be considered as 0.2m.
 - Actual clear walkway is the width available between frontage zone and edge zone.
- Surface:**
- Footpath should have tough and anti skid surface.
 - Consistency should be maintained for design, colour, texture and level to provide clear visibility and visual continuity so as to get easily noticed by vehicular and pedestrian traffic.
- Level:**
- Footpath should be above carriageway and separated by curb. Footpath should have uniform height of maximum 150 mm above road level.
 - It should have gradual slope towards street storm water drain to avoid water accumulation.
 - Suitable ramps should be provided at entry/exit of footpaths.
 - Where raised footpath is not possible, railing or curbstone type separators should be provided to create walkway segregated from carriageway.
 - Footpaths should continue at the same level at property entrances and at the junctions where side street meets the main street.

➤ Footpath level should be maintained at entry to lanes / smaller roads meeting main road. Heavy duty paving blocks to be used in this portion. Suitable ramps to be provided outside footpath area for vehicle access. Footpath width shall not be reduced to provide ramps.

➤ Design of footpaths should be such that it provides convenience to pedestrian as well as provides for vehicular access to adjoining properties.

➤ A gentle ramp needs to be provided in parking bay or at road side edge of the footpath to give access to property entrances without altering the surface levels of the walkway. It is to be seen that such vehicular access ramp does not hamper clear walkway for pedestrians. Ramp can be provided at road side edge of footpath only when the clear walkway width is 2.5m or more. This makes it easy for the pedestrians since the levels are not disturbed at every property access gate.

➤ Ramp, steps at the property entrance and compound wall of property should be within the property premises without any encroachment on footpath. Footpath width shall not be reduced to provide ramps/steps. Gate of the property should be inside opening type without causing any obstruction on footpath.

➤ **In any case footpath level should not be lowered for the following reasons:**

- ❑ Pedestrians find it inconvenient to change the level frequently.
- ❑ Motorists tend to use the footpaths more often like a vehicular way or parking space and dominate the pedestrians making it unsafe for them.
- ❑ The lowered access portion is bound to get sunk due to frequent vehicle movement. This causes its wear and tear causing water logging during rains.
- ❑ Bollards can be used to restrict the vehicular movement along footpaths.

Residential zone

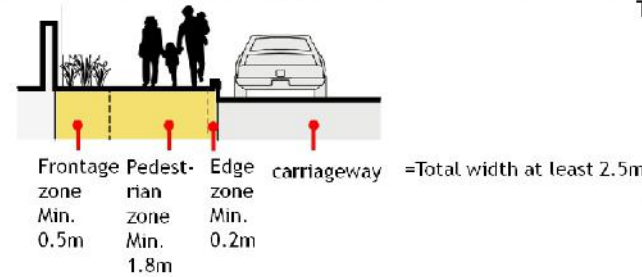

Treatment at property entrances

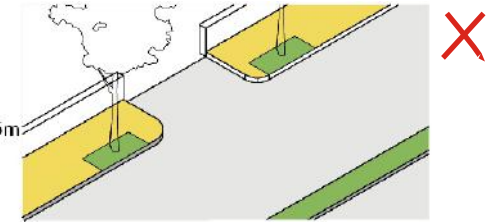

Mixed use zone

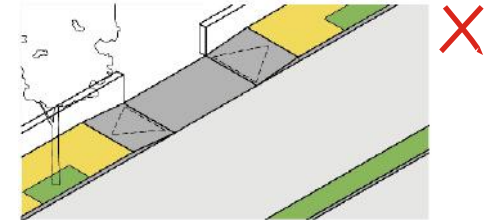
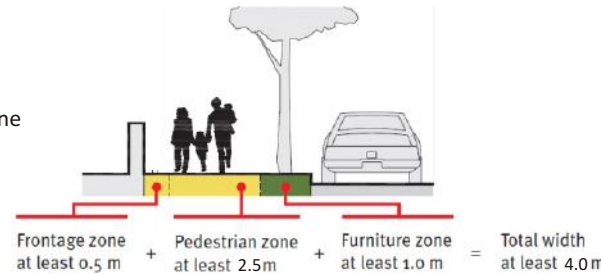

Commercial zone

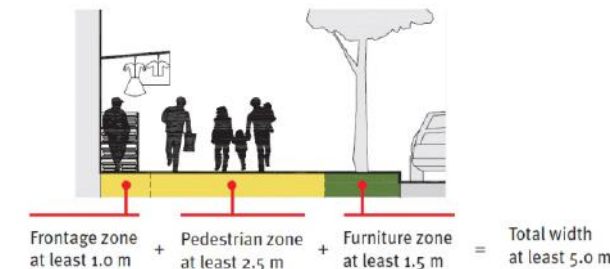

Ramp within footpath at edge only if clear walkway width available at ramp is minimum 2.5m

High-intensity commercial zone

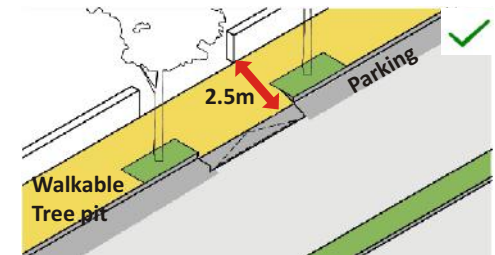
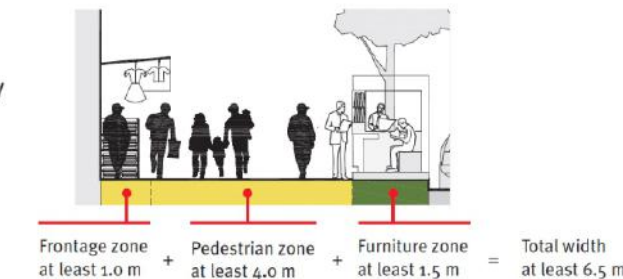

Ramp in parking zone / road side if clear footpath width is 2.5m or less

Pedestrian zone width shown in above figures is the minimum specified. Width should be increased as per the adjacent land use and pedestrian density (IRC: 103- 2012, clause no. 6.1.5.2).

3.2 CYCLE TRACK

Cycle tracks are reserved portion of the street only for cyclists. These are essential components of wide streets which safeguard cyclists from fast moving vehicles and encourage the use of cycles.



No continuous segregation



Not enough space between bollards to pass



Cycle track segregated by verge.

General Design Recommendations:

Width :

- Clear unobstructed cycling zone at least of width 2m for one way movement and at least 3m for two way movement with vertical clearance of 2.4 m
- Cycle tracks should have adequate clearances from the bollards plantation, parking areas for car door opening and street furniture
- Cycle track should be at level +100 mm from carriageway. At grade cycle tracks segregated from carriageway with curbstones can also be considered to suit site conditions.
- Gentle ramp or raised driveway should be provided for motorized vehicles at entry points of properties or access to buildings whereas cycle tracks should continue at same level.
- The surface of cycle lanes/tracks should be leveled without any obstructions like utility covers, plantation etc.
- Asphalt or concrete is recommended surface material for cycle tracks. Paver blocks should not be provided.
- Colored surface treatment is recommended to improve the visibility of the bicycle operating area.
- Proper gradient should be maintained with provision of storm water drains to avoid water logging.



A cycle track in Amsterdam with parking spaces for cycles adjoining cycle track



A cycle track in Delhi with buffer of tree line

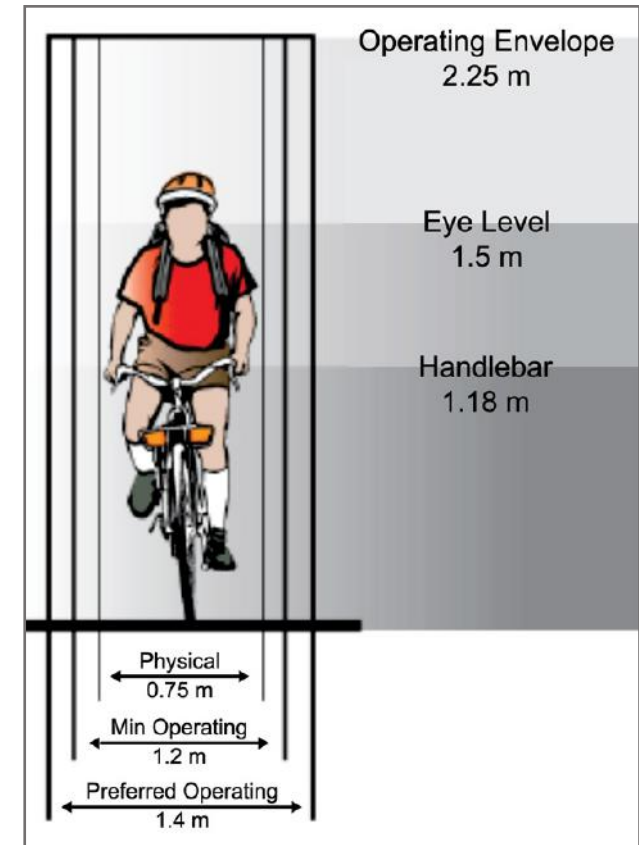

Space requirements for cyclist
Source: Culvert city bicycle and pedestrian master plan design guidelines

Cycle track and footpath are ideally segregated by plantation/verge as buffer.

Cycle tracks are to be segregated from vehicular lanes by parking lane, plantation strip or a verge.

Parking on dedicated cycle lane or cycle track should be strictly prohibited.

Signages, signals at junctions should give consideration for safety of cyclists.

Cycle tracks should be well lit and have tree shade for comfort of the cyclists.

Dedicated parking spaces with well designed cycle stands should be provided for cycles near transit stations and within off street parking in commercial areas.

Provision of cycle parking is recommended within the Multiutility zone or parking zone of the streets.

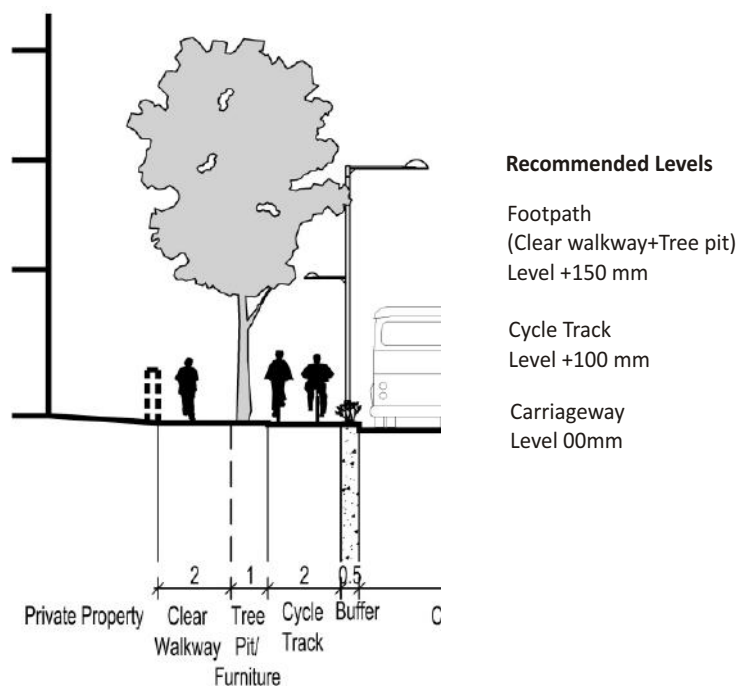

Segregating cycle tracks from pedestrian paths.

Continuity of cycle track

Cycle track or providing a dedicated space for cyclists is an absolute need of time. Improving the quality of cycle infrastructure is imperative for providing respect, encouragement and safety to cyclists so that more and more people begin to use cycles.

Intersections are places where the cyclist may need to change the direction. Cycle tracks should not abruptly end especially near intersections.

Recommendations:

- It is preferable that continuity of cycle tracks be maintained across road junctions by using appropriate techniques. Only if this is not practically possible on mobility corridors considering limitations of junction design, cycle tracks can be merged with the traffic lane before a major junction at minimum possible distance of up to maximum 50m.
- Cycle tracks should be marked in green or blue color where it is merged at the junction to highlight cyclist priority. A stopping bay for cyclists near the stop line of the junction should be marked.
- Bollards should be provided at the start and end of cycle track to prohibit vehicles entering in the cycling zone. Bollards should be of height not more than 0.4 m to make sure that cyclists can easily pass through them without any hindrances. The gap between two bollards should be such that handle of the cycle can easily pass through it without having to lift the bicycle.



3.3

BUS STOPS

- Bus stops are one of the essential component of streets.
- Location and design of bus stop affects the movement pattern of vehicles and pedestrian and other activities in general within its catchment area.
- Flyovers and underpasses should be constructed only after considering existing locations of bus stops and their likely expansion in view of intended increase in number of bus commuters. Convenience and need of bus passengers should be given prime consideration.

General guidelines for bus stops

- Ideal minimum dimensions of bus stop are – 10M X 1.5M X 2.2M ht. If passenger demand is high, longer bus shelters would be necessary.
 - Multiple bus shelters of recommended size should be constructed at busy location along mobility corridors.
 - Design should be such that it does not obstruct visibility of surroundings and pedestrian flow on footpath.
 - The design should be compact, robust with anti skid, leveled floor space and with preferably cantilever roof, sufficient shade and light.
 - Seating if provided should be compact and minimal.
 - Guard rails / railings at the curb edge should not be provided.
 - It should have provision for display of route info maps, digital sign boards apart from advertisement boards. Advertisements should not obstruct route information display maps, statutory signage etc. The displays and advertisement boards should be placed on bus stop such that they are perpendicular to pedestrian and vehicular movement and not at the backside of the stop, because then it creates an opaque space behind the bus stop, which pedestrians do not use.
 - Night illumination is a must on bus stops.
 - Bus stops should have emergency phone numbers/ police help line numbers/ PMPML numbers displayed.
 - Ideally a tree should be located near uni pole bus stop providing shade to the passengers.
- Bus stops should have proper provision of storm water drain to avoid water logging especially during monsoons. Water absorbing soil pits can be done at bus stops. Consideration should be given to gradient and raised curbs to drain off water at the bus stops.
 - Bus stops should not take space away from footpaths, cycle tracks and carriage ways. They could be constructed in parking bays on bulb-outs which should be at the same level as the adjacent footpath or in MUZs.
 - It should not obstruct pedestrian flow or cycle movement and avoid conflict with vehicular movement in any case.
 - Bus stop to be in the vicinity of the junction but should be located at a distance of 50 m away from any junction.
 - Parking should be prohibited in the zone 50m before bus stop and 20m after bus stop.
 - Multiple bus stops to be provided at busy locations where route segregation is possible and where frequency of buses is high at peak hours.
 - Bus stops should be accessed by zebra crossings, median breaks, refuge islands.
 - Height of the flooring of the bus stop should not be more than 150 mm .
 - Permanent lane marking should be done to distinguish bus waiting area near bus stop and ensure proper alignment of buses. Bollards/railings/reflective cats eyes to be provided to guide the bus to align properly with the bus stop. Bollards and railings will also prevent vehicle parking in the vicinity of bus stop.
 - Road geometry mainly road width, footpath width, cycle track determine the location of bus stop. Location of parking bays should be determined After identifying a convenient location of bus stop.
 - Bus bays should be avoided.

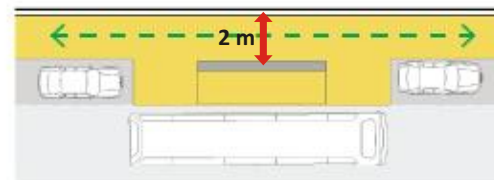

Bus stop designed in parking bay keeping clear walkway undisturbed.

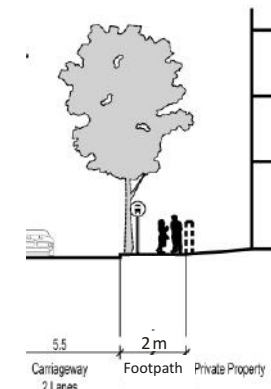

Uni pole Bus stop is recommended in case of narrow footpaths.

3.4 BRT LANES

- Dedicated Bus lane provides for high capacity high quality public transport system at comparatively lower costs.
- Exclusive ROW for bus is the basic requisite for successful implementation of BRTS.

General Design Recommendations for BRT lanes

Bus priority lane or dedicated bus lane is considered to be the most effective and economical way of improving public transport since it increases the speed of the bus thereby reducing headway, reducing delay and improving fuel efficiency. Also fewer buses are required, more people get transferred & people find bus more attractive and convenient.

- Dedicated bus lanes are recommended on roads with ROW 30m and above.
- Width of bus lane is recommended to be min 7 m undivided for 2 way bus flow.
- Bus lanes should be segregated from main carriageway by median / railing.
- Proper provision for street crossing should be made for commuters to access the median bus stations in BRTS. There should be provision of mid block crossings at every 150 m to cross the street. Signage and signals to be provided where crossings are required.
- Pedestrian refuge of min. 1 m width should be provided at all crossing locations.



Rainbow BRT, Pune

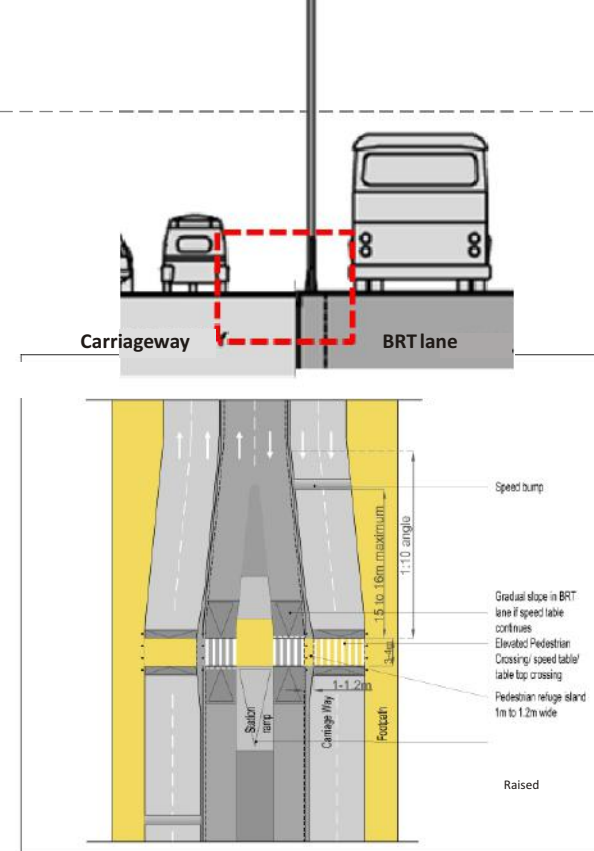

BRT station access table top crossing detail for BRT lane on existing pavement

Case 1: BRT lane on existing pavement-

It is recommended to provide gradual slope to the elevated pedestrian crossing (Table top crossing) in the bus lane as shown in the plan below.

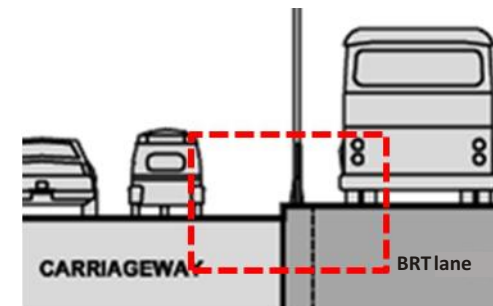

Case 2: Constructing BRT lane on a new road in green field areas-

It is recommended to provide BRT lane 150 mm high than the existing MV lane as shown in the figure above. It will ease the passenger access from adjoining footpath to BRT station with elevated pedestrian crossing. In this case, BRT lane would have uniform level.

3.5

CARRIAGEWAY

Carriage way is the reserved portion of the street only for moving vehicles. It needs to be well defined and demarcated with lane markings. It is divided (by railing/median) or undivided depending on ROW for to and fro traffic. Carriage way should not be used for parking, hawking, walking and laying utilities.

Slip roads with adequate carriageway width as per traffic volume shall be provided on streets with flyovers.

Design Recommendations

Width :

- Width of carriageway should be uniform through out the length of the street till it changes its hierarchy. Ideally Carriageway widths could be changed only at intersections.
- Carriage way on any street should be demarcated with yellow colour lines and reflective cats eye on them. Internal lanes should be marked in white color dashed lines. Marking shall be with thermoplastic paint.

Surface quality and material:

- Carriageway should have well finished and plain surface with proper longitudinal gradient and camber to enable water drain off. The longitudinal slopes, super elevations and cambers should be designed as per IRC norms.
- While deciding the surface material of the carriage way PMC STAC committee report must be referred. Cross drains and utility ducting to be covered with compact paver blocks.
- Utility services should not be placed on or beneath carriageways as they require digging of road for repairs and maintenance. This degrades the surface and disturbs the pedestrian and vehicular traffic flow. They should be shifted to shoulders and in Multi-utility zones demarcated on streets.
- Construction technology and material specification should comply with IRC and STAC committee report of PMC.
- The material density and compaction shall be as per the specification of sub grade, where it is earthen shoulder and the required cross fall should be maintained.
- Paved shoulders should have the specification consisting of sub base and surfacing course and conforming to the relevant specifications of corresponding items for pavement layers.
- The level of street and storm water drain in the shoulders should be so designed that water from the road does not enter into any adjoining property and easily enters the drain.

3.5.1

Shoulders

- Shoulder gives adequate support to the pavement besides safety and also drains off surface water from the carriage way to the side drains. Where side footpath is not constructed, normally a shoulder exists which needs appropriate construction and maintenance for proper functioning of the road.
- Shoulder should be given proper outward slope for efficient draining of surface water from carriageway.

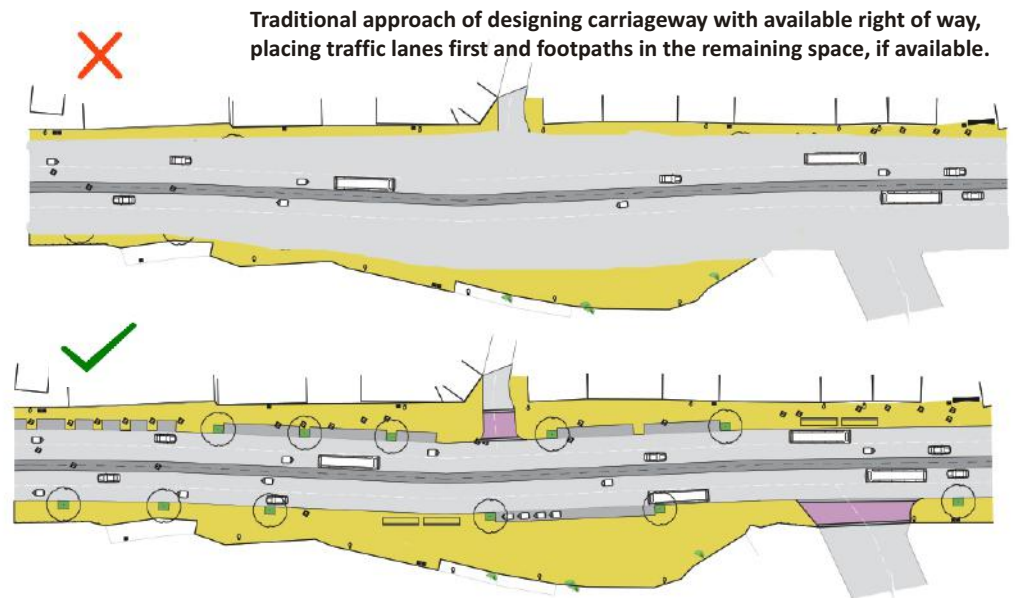

3.6

ON STREET PARKING

2-wheelers and cars are most common private vehicles parked on street. Autos, cabs, school buses are public and semi public vehicles consuming road space for parking.

It is to be noted that provision of on-street parking is an additional facility provided by the municipal corporation and is not the right of the citizens. Solving the street parking issue requires Policy intervention.

Refer to Pune municipal corporation's draft parking policy to understand need of parking control and management and various strategies to restrict parking supply and demand in Pune.

General Recommendations

- Intersections and other critical locations should be kept free from parking and other encroachments up to min 50m from junctions on all arms.
 - Suitable curbside lengths should be kept clear of parked vehicles near bus stops.
 - Parking should not be allowed on footpaths and cycle tracks or other corridors meant exclusively for pedestrians and cyclists and vehicles thus parked should be penalized.
 - In central areas, street parking may be permitted on one side of the road one day and on another side on another day depending on the site location. Some streets in the city could be declared as ' No parking ' streets in consultation with traffic police.
- The provision of on-street parking depends on the land use context, ROW and type of street.
 - Where full time on street parking is provided, curb extensions should be designed at crossings for pedestrian safety and visibility.
 - The area allotted for parking should have a clean and leveled surface, free from water logging with proper water drain facilities.
 - Strong enforcement for prohibition of parking on footpaths, cycle tracks and near bus stops.
 - Strong enforcement to avoid double parking or halting vehicles on busy, narrow streets.
 - Use of bollards at the ends of the parking strips is recommended to prohibit undisciplined parking and encroachment.
 - It is recommended to distinguish the parking lane by use of colored surface treatment, line marking by thermoplastic paint or use of line of contrasting colored blocks. Signage should also be provided accordingly.
 - No parking zone should have curb painting and shoulder line marking in yellow. Signage with directional arrow should be located at beginning and end of No parking zone.
 - Use of permeable grass pavers is recommended in parking areas.

- A narrow verge is recommended along the edge of the footpath to ensure that vehicle overhangs do not intrude on the footpath. Provide 0.5 m horizontal clearance in the Edge zone where there is parallel on-street parking.
- Parking area should be well lit and have necessary signage.
- Parking belts of local narrow street should have plantation which also act as TCM.



Uneven surface affecting the discipline and proper alignment of parked vehicles.

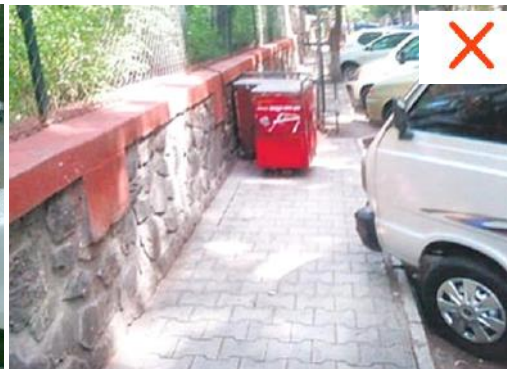

Vehicles intrude on footpaths affecting the pedestrian movement.

Recommendation for Parking Layout

- Parallel car parking is recommended on streets where parking is permitted. Inclined and perpendicular on street car parking should be avoided.
- Angular two wheeler parking on center stand is recommended on streets with provision for road side parking.
- On street parking should be permissible only in designated spaces and in multi-utility zones.
- Parking on mobility corridors during peak hours should be avoided. Parking should not be allowed for min 50m on all arms near the intersections on mobility and feeder streets.
- Parking bays at road side need not be continuous. They should be interrupted at max. 22 m to provide bulbout spaces for street furniture, vending and pedestrian crossings.
- Vending spaces should be placed in a bulbout in the parking bay (as pictured in right) or in the furniture zone, leaving clear space for pedestrian movement.

Recommended min. dimensions

Car park = 2 m x 5m parallel parking

2 wheeler parking = 1m x 2m

Cycle parking = 1m x 2m

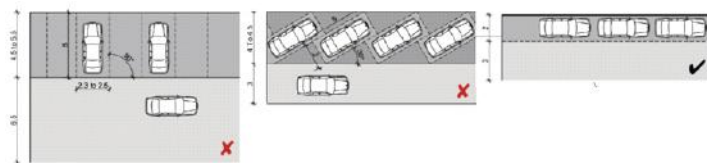

Parallel parking for cars is the most efficient parking layout in terms of the number of vehicles relative to the area occupied. Parallel parking is recommended because it also takes away minimum road space from other road users. The same parking lane can be used as perpendicular parking for two-wheelers.

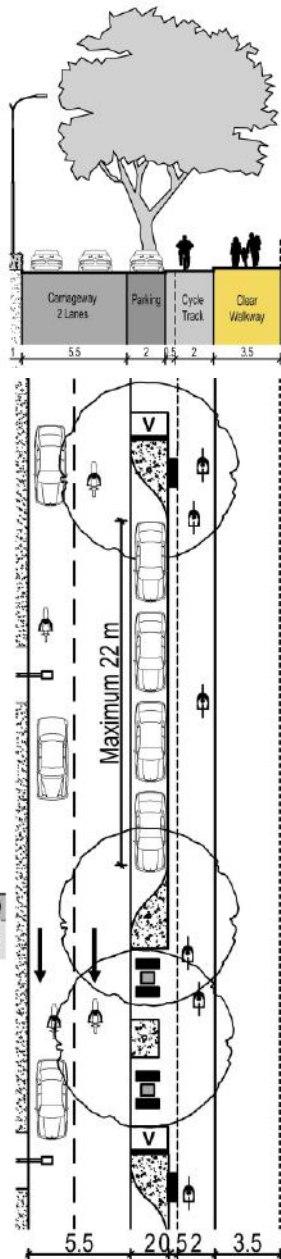

Maximum length of a parking bay should be 22 m. Parking bays should be given at intervals keeping the space for seating, vending in between two parking bays.

Recommendations for Rickshaw stands

- Rickshaw stands should be preferably located—
 - Within MUZ wherever provided.
 - Near bus stops and transit stations.
 - Near junctions but 50 m away from the intersection of local and feeder roads.
 - Mid blocks on local streets.
- Capacity of rickshaw stands should be limited to not more than 7 autos in one parking zone. Space should be dedicated for auto stands near hospitals and commercial area at places of high footfalls.
- Rickshaw stands should be located alongside footpaths for safety of passengers at time of boarding. Autos should not be parked on footpath or cycle tracks.
- Space allotted for rickshaw stands should be well demarcated by line marking, should have leveled and clean surface and is well lit and preferably have tree shade.
- Parking and halting of auto rickshaws should be prohibited up to 50 meters prior to the bus stop and 20 meters after the bus stop.
- Rickshaw stands should be located at road side with orientation along the traffic direction, 15 m away from raised pedestrian crossing.
- Rickshaws should not wait at the entry or exit of footpaths, cycle tracks and in pedestrian crossing zone.

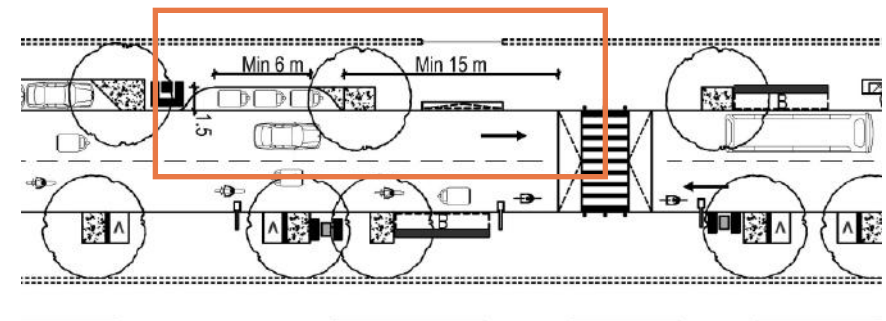



Pedestrian crossings

Traffic calming measures

Speed breakers

Traffic signals

Central medians

Railings

Bollards

Street lights

Street furniture

Signage , markings

**Make streets safe, clean,
attractive and comfortable
for all users.**

SAFETY ELEMENTS

Includes introduction to elements, design recommendations based on standards and norms for all such street elements related to safety and comfort of the street users.

4.1

PEDESTRIAN ROAD CROSSINGS

4.1.1 At grade pedestrian crossings

At grade pedestrian crossings are to be provided at all intersections as large number of pedestrians cross the street at intersections.

To ensure pedestrian safety and convenience, crossings should be designed so as to have direct and shorter route to the other side of street.

Safe pedestrian road crossings shall be provided also on streets with flyovers and underpasses.

Common formats of crossings

- Signalized crossings at junctions with refuge islands.
- Mid block crossings supported by traffic calming measures.

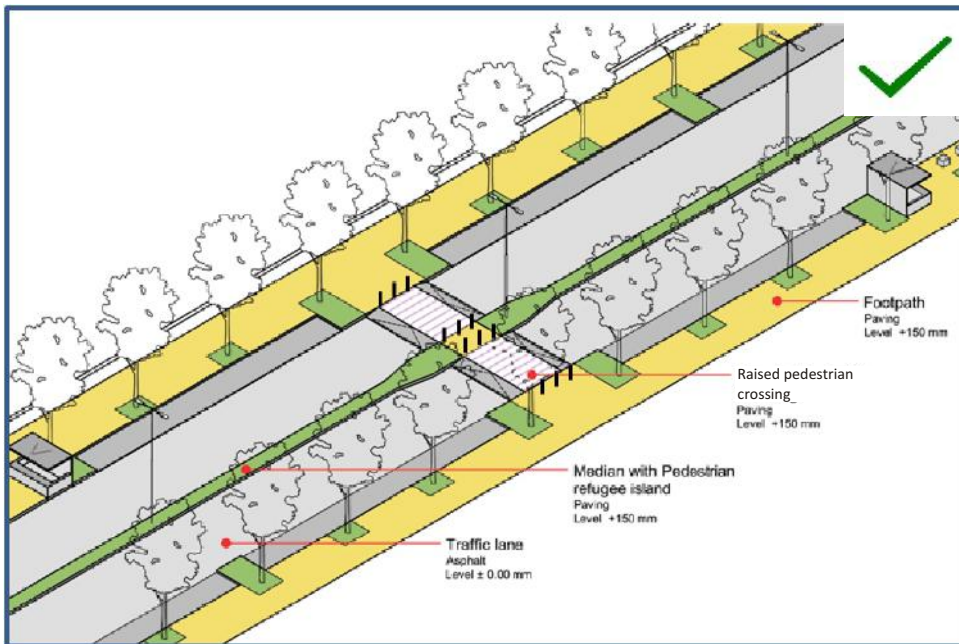

Ideal design for at grade crossing showing raised zebra crossing and refuge island



Zebra Crossings

- Pedestrian crossings should be provided at every 150m distance depending on the surrounding landuse and pedestrian footfall. (IRC: 103 - 2012, clause no. 6.7.2 Table 3) In no case should its width be less than 3m. Crossing width can be more as per pedestrian density.
- Zebra crossing is mandatory at all Intersection crossings.
- The design and dimensions of zebra crossing should comply with IRC 35-1997 code of practices for road markings (with paints). Following are the recommendations in IRC 35-1997-
 - The zebra marking of a pedestrian crossing consists of equally spaced white strips Generally 0.3 m wide with a gap of 0.3 m in accordance with IRC 67-1977.
 - Zebra crossings to be painted with thermoplastic paint of white color. Zebra crossings to be highlighted by reflective cats eye and should be easily visible with sufficient lighting. They should always be accompanied by stop line.
 - Zebra crossings to be from edge to edge or footpath to footpath connecting refuge spaces in between.
 - Tactile pavings should be embedded in zebra crossings to guide specially abled people.
 - Medians, railings or any other obstructions should not be placed on zebra crossings.
 - Distance between STOP line and edge of zebra crossing should be 2m (as per the 'Pedestrian policy of PMC').
 - Traffic signal pole should be located midway between STOP line and edge of zebra crossing. (as per the 'Pedestrian policy of PMC').

4.1.2 Refuge Islands

- Refuge islands are intermediate spaces where pedestrians can wait / pause while crossing the street. These are safe locations which help pedestrians to cross the street safely.
- 'Refuge islands to be provided at all crossings at spacing of two lanes or maximum three lanes.
- The corner traffic channelizers or median spaces near intersections can to be treated as refuge spaces. The minimum width of refuge island to be 1m.
- Refuge islands to be highlighted by reflective bollards and signage and to have adequate lighting.
- Refuge island should be as shown below, with pedestrian crossing at the same level of carriageway and landscape area or platforms on both sides to protect pedestrians. Island width should be at least 3 m in order to be accessed by wheelchair users.
- Light poles, signal poles and signage if any, should not obstruct pedestrians' movement and vision. Advertisements should not be allowed on the entire refuge islands.



Refuge islands at the intersection, Ahmedabad

4.1.3 Grade separated pedestrian crossings

- There are two types of grade separated pedestrian crossings:
 - 1) Foot over bridge (FOB) - Pedestrian crossing is on a bridge at specified height over the street level. Access to the bridge is normally by steps. In certain cases, lifts are also provided.
 - 2) Pedestrian subway - Pedestrian crossing is at a level below the street. Access to the subway is by steps and ramps. The street above can be hump type to reduce the number of steps to the subway.
- There are several issues with grade separated crossings due to which pedestrians find the crossing very inconvenient. Hence these remain largely unused. At grade crossing should always be preferred as it is most convenient for all pedestrians.
- FOB and subways should be completely avoided at intersections since pedestrians can cross the road when one of the signals is red.
- FOB or pedestrian subway should be considered only in very exceptional cases as a last option when all attempts to provide safe at grade crossing have failed. Final decision about grade separated crossing shall be based strictly on the findings of necessary scientific surveys and on satisfying stipulated warrants as per applicable codes and standards.



Foot over bridge at Vishrantwadi, Pune

4.1.4 Mid block crossing recommendations

- Mid block crossing should be provided between intersections with spacing as given in IRC: 103-2012 depending on the local needs of pedestrians.
- Footpath platform should be extended (bulb out) at the crossing for better visibility of oncoming traffic to pedestrian (and vice versa). This also provides a shorter path for pedestrians to cross the road and prevents vehicle parking on the crossing.
- At Grade Mid-block crossings can be staggered so that pedestrians are oriented towards oncoming traffic
- Refuge Islands are must at mid block crossings.
- Raised crossing or table top crossing are also recommended. The level of raised crossing should match with the height of the footpath.
- Crossings should have proper signage and illumination. Reflective paint markings, cats eye, bollards to be used for high visibility. Traffic calming measures should be provided as per requirements.



Mid block crossing in Pune

4.2

TRAFFIC CALMING MEASURES

- Traffic calming measures are ways of calming or reducing the speed of vehicles on streets in order to reduce the possibility of accidents.
- Motorists in Pune tend to use interior neighborhood / local streets to bypass main street traffic. Usually they tend to raise the speeds as there are no obstructions like signals, speed breakers on such streets and also less traffic.
- Traffic Calming measures are effective ways of ensuring safety of pedestrians and vehicles especially on neighborhood and local streets.
- There are many ways of calming the traffic. Apart from the TCM measures given in the diagram, trees, parking etc also act as TCM.
- Traffic calming consists of engineering and other measures put in place on roads with the intention of slowing down or reducing motor-vehicle traffic to enable safe mobility of pedestrians and cyclists.
- This can be broadly achieved by creating full or partial physical barriers, change in alignment, variation in surface levels and materials and with visual barriers.

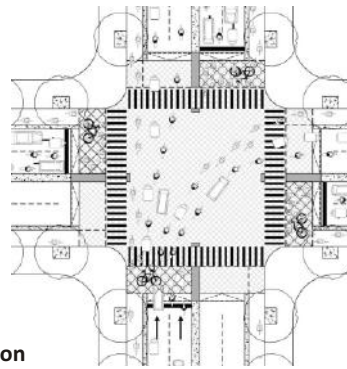

Raised Intersection

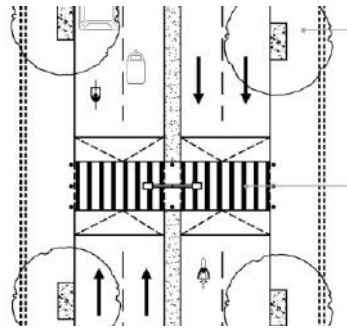

Raised Crossing

Staggered on street parking as chicane

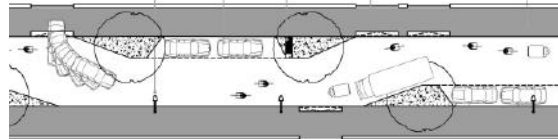

Footpath continuity at junction

Types of traffic calming measures

Various types of TCM

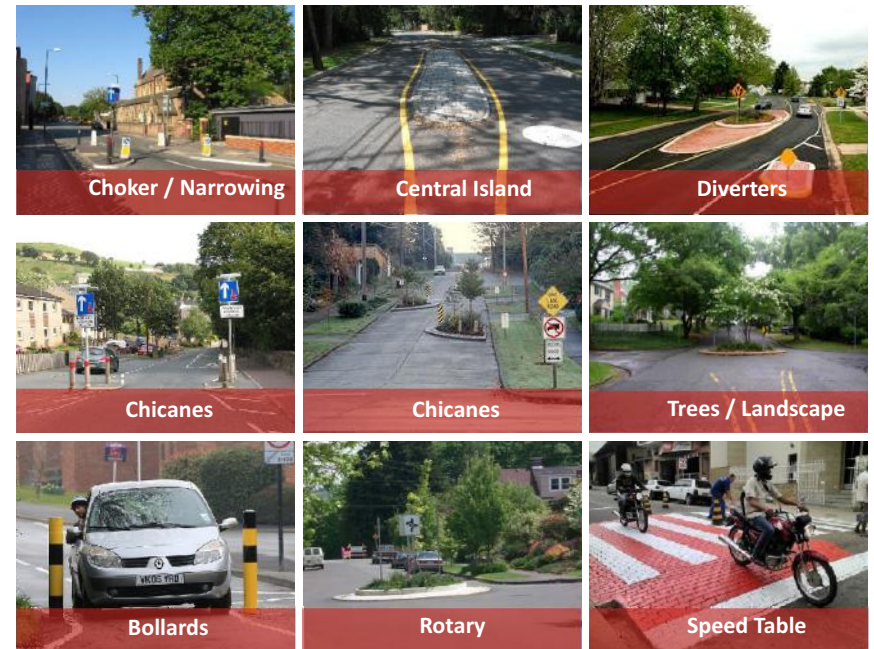

General Design Recommendations

TCM are recommended near crossings where residential local streets intersect the feeder streets or mobility corridors.

Distinct markings, signage, signals and proper lighting are mandatory within zones of TCM.

Speed humps and rumble strips are recommended at all mid block crossings on roads with ROW 21m and more.

Curb extensions with material variation are recommended for all junctions on roads with ROW 9m and more having high pedestrian activity like mixed use streets and commercial streets.

Traffic circles are recommended on all such roads of ROW 18m and more which are newly developed on the city outskirts wherein the traffic volume is considerably low at present.

4.3

CENTRAL MEDIAN, RAILINGS AND BOLLARDS

4.3.1 Central median

- Medians or dividers are raised barriers that separate the street in two halves and direct traffic flows.
- Medians help to streamline traffic and avoid conflicts between traffic moving in opposite directions.

Design recommendations

Railings or concrete dividers need to be designed in such a way that they are easy to replace or repair but difficult to shift from position.

Wider medians are preferred wherever possible (depending on ROW of road and specified footpath width) so that refuge islands of adequate width can be provided for pedestrian crossing at intersections and mid block locations.

Mid block crossings for pedestrians to cross the road are necessary and are described in section 4.1.4.



Medians to have colors which will make the median easily visible . They should have reflective materials like cats eyes fitted on it so that they are easily visible in the night. This will avoid accidents.

4.3.2 Railings

- Railings may be used on medians and dividers.
- Railings need to be aesthetically pleasing and should enhance the look of the street. At the same time their design should be robust, difficult to tamper or break and difficult for people to easily climb or sit on it.
- The height of railing to be a maximum 1.1M.
- Railings to be fixed with strong concrete base and should be continuous. Care should be taken that they are uniform and do not protrude out in the MV lane or BRT lane causing accidents.
- Railing on the footpath are generally to be avoided as it creates hindrance for pedestrians in accessing the footpath.
- Railings may be considered for footpaths in the vicinity of junctions to ensure that pedestrians can cross only at the designated crossing and also to prevent vehicular movement on footpath.



4.3.3 Bollards

Bollards are entry restricting elements on streets whose purpose is to discourage vehicles from entering into pedestrian space or cycle tracks. Bollards are also used to demarcate and safeguard any space for pedestrians.



Location	Gap / spacing	Height	Remarks
On Footpath	0.6m	0.5m-0.7m	Less gap and height is intended to restrict vehicle entry and facilitate pedestrians carrying luggage. (one gap of 0.9m should be left for wheel chair users).
On cycle tracks	0.7m	0.2-0.4m	This will not facilitate cyclists carrying milk cans or cylinders hung on sides but will restrict entry of two wheelers into cycle tracks.
On streets / refuge islands etc	0.8m	0.9m	The height can be increased upto 1.1m in order to make the bollard clearly visible.

Recommendation for location and dimensions of bollards.

Design Recommendations

- Bollards can have variety of designs and shapes but the design should not cause hindrance to pedestrians or cyclists in any way.
- Choice of material has to be made such that they are easy to replace and procure but difficult to break or steal. eg: Concrete bollards.
- Bollards should have reflective radium tape fitted on it to make it easily visible in the dark.
- Bollards should be provided on footpath at strategic locations in the vicinity of road junctions to prevent entry of vehicles. Railings should also be provided for the purpose as necessary. Combination of bollards and railings would prevent vehicle movement on footpath which is rampant near junctions.

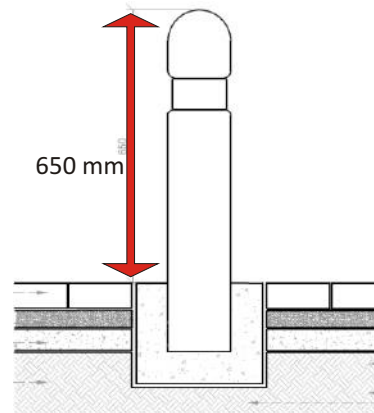

Regular bollard

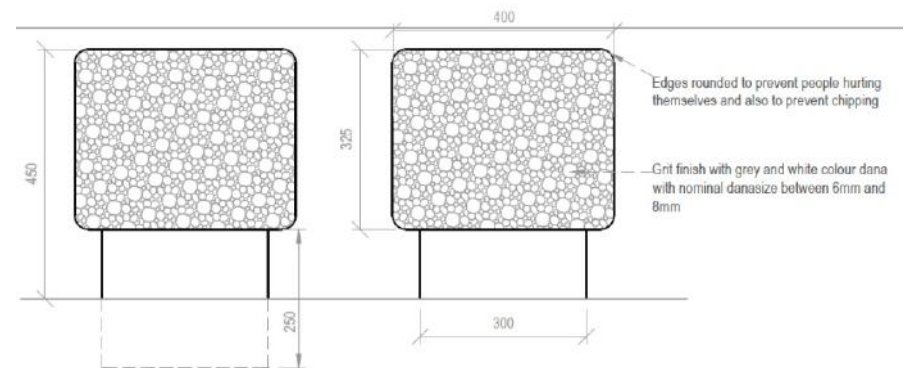



Seating bollard

4.4

SPEED BREAKERS

- Speed Breakers are induced elements on the streets whose sole purpose is to reduce vehicle speeds.
- They are ideally introduced where the surrounding land use expects low speed or where many accidents take place due to over speeding.

There are 3 types of speed breakers :

Type	Location	Remark
 <p>Speed BUMP</p>	Local / Neighborhood Streets	Speed Bumps to be moulded fibre type fixed properly and maintained.
 <p>Speed HUMP</p>	Feeder Streets / Mobility Streets	Humps to be bitumen / concrete. Should be spaced at midblocks.
 <p>Speed TABLE</p>	Mobility Streets	Tables to be bitumen / concrete. Should be spaced at midblocks.



Design Recommendation for speed breakers

- Speed bumps, speed humps and speed tables are the three types of speed breakers which need to be introduced on urban streets.
- They should be supplemented by proper markings, cats eyes and signages making them clearly visible at night time.
- Hump type speed breakers should be painted in alternate white and black color pattern. Bump type moulded speed breaker can have yellow and black color.
- Speed bumps should be installed from edge to edge of the road without leaving any gap at the road side (especially on local streets with no footpath) as vehicles use such gaps to avoid the speed bump. This leads to unsafe conditions for pedestrians and vehicles alike.
- Speed humps should have diamond shaped white thermoplastic paint marking on it.
- Provision for flow of rain water should be made at the sides to prevent water logging.

4.5

STREET LIGHTS

- Lighting of streets is one of the most important and essential elements for safety of road users including pedestrians.
- Good quality light promotes safer environment by ensuring inter-visibility between users.
- Quality of lighting has major impact on perceptions of security especially for pedestrians and cyclists.
- Lighting should be designed to ensure that both the vehicular carriageway and pedestrian/cycle path are sufficiently illuminated.
- Street lights can have various designs and appearances depending on the type / theme or aesthetic significance of any street.

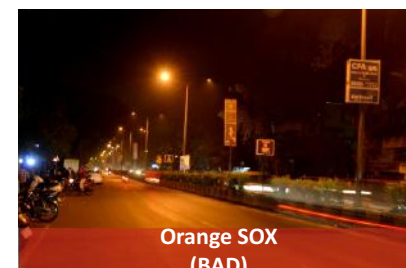
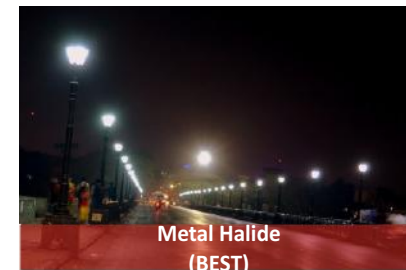

General design recommendations

- Lighting installation should generally be placed within
 - Verge
 - MUZ
 - Central medians
 - Curbside of roads
- Street light poles should not obstruct the pedestrian or vehicular traffic flow and visibility.
- Placement of street lighting should be co-ordinated with other street elements like trees, signage, advertisement hoardings. Height of the light poles should be sensitive to the scale of adjacent built environment.
- Footpath and street light fixtures should share the pole wherever feasible.
- It is recommended to use only LED for street lighting. LED is preferred because of lowest energy consumption.
- The height and spacing of light poles and illumination characteristics should comply with the IRC standards.
- Solar lighting systems should be encouraged subject to economic and security considerations.
- Street lights should have throw of light downwards and sideways down towards the street. They should have an out reach arm protruding toward the street.

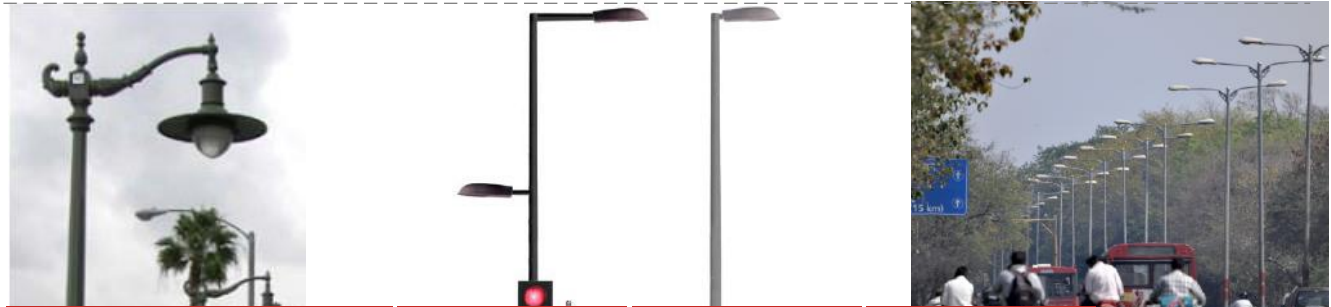

Location of street light	Spacing between two light poles (m)	Height of the light pole (m)	Length of the outreach arm (m)	Intensity of light (Lux)
On Central Medians(two arm street lights)	25 - 30	9 - 15	2 - 4	30
In between BRT lane & MV lane	25 - 30	9 - 15	2 - 4	30
In between footpath & MV lane	25 - 30	9 - 15	2 - 4	30
In between footpath & cycle track	12-16	4.5-6	1 - 2	25
On footpaths for pedestrians only	15	6.5	1 – 1.5	20
High masts at Intersections	-	10 - 15	2.5-4.5	50
High speed vehicular streets	30-33	10 - 12	2.5-4.5	30
Local / Neighborhood Streets	25-27	8-10	1 – 1.5	25

Rrecommendation for street lighting.
 Ref: International Best practices &
 National Street Lighting manual

4.6

STREET FURNITURE

- Purpose of street furniture is to cater to the comfort need of the road users especially pedestrian and cyclist.
- Well designed and properly placed furniture inculcates sense of discipline among road users, acts as traffic calming measure and adds aesthetic value to the street.
- Following are the commonly used street furniture:
 - Seating/benches
 - Trash bins
 - Bollards and railing
 - Signage/ info kiosks
- Street Furniture brings in life on the streets and improves its aesthetics and usability.

Design recommendations

- Should be of durable material, easy and cheap to maintain, safe to use, easily available in case of repairs and replacement and aesthetically pleasing.
- Should be placed such that it does not obstruct the pedestrian or vehicular flow.
- Should be placed along all the streets. The location, type and quantity should be decided depending on the adjacent land-use of the roads and user activity and space availability.
- Street furniture should be convenient to use and have universal accessibility.
- All street furniture should be suitably placed to allow access for street cleaning.
- Street furniture is to be provided at all such locations having high public activity and pedestrian flow like commercial plazas public buildings, recreational areas, transit stations, parks and gardens, educational institutes, market areas, shopping malls etc.
- Street Furniture should be placed within MUZ wherever provided.

Recommendations for Seating:

- Benches or seating should be provided at the building/ frontage edge of the footpath and ideally with provision of shade.
- Where seating is oriented parallel to the curb, it should face toward buildings when located in the furnishings zone, or away from buildings when located in the frontage zone.
- Where sidewalk width permits, seating in the furnishing zone should be perpendicular to the curb.
- Seating should be designed to encourage sitting and to discourage lying down.

Recommendations for Trash bins:

- Size of trash bins should be such that it does not occupy more than 2 sq.m of space of any street.
- Trash bins should be located at intervals of not more than 200m.
- Trash bins should be located ideally on the edge zone or within verge between carriageway and footpath.
- Design of trash bins should be such that it conceals the litter bags, is covered, facilitates easy removal of litter and cleaning of bins.
- It is recommended to provide for separate bins for segregating the wet waste and recyclable waste.
- Trash bins should be placed near all transit stations, parking areas and junctions.



4.7

TRAFFIC SIGNS

Traffic signs have been prescribed in the Motor Vehicles Act 1988 for following:

- Road Safety Rules
- Permissible Speed and Access.
- Warning about potential hazards
- Directions and distances of destinations, landmarks and suburbs.

Commonly used road signs as per IRC 67-2012 are as follows:

Mandatory/Regulatory Signs: In accordance with the Motor Vehicle Act, 1988, every driver of a motor vehicle shall drive the vehicle in conformity with any indication given by the mandatory signs and not obeying these signs is an offense. These signs are generally on circular boards.

Cautionary/warning Signs: Cautionary signs are meant for cautioning the driver about the hazards lying ahead on the road. These signs are on triangular boards.

Informatory Signs: These guide the road users regarding the distance and directions roadside facilities & destinations. These signs are on rectangular boards.



One way



Tow away zone at No parking



Speed limit



No free left



Prohibited parking in non motorised lanes



Heavy vehicles prohibited



Fig. 15.10 Side Road Left



Fig. 15.06 Left Reverse Bend



Fig. 15.11 Y-Intersection



Fig. 14.52 Compulsory Cycle Track/Cycle Only



Fig. 15.12 Y-Intersection



Fig. 15.48 Dangerous Dip



Fig. 14.56 Bus Way/Buses Only



Fig. 15.51 Rough Road



Fig. 15.50 Rumble Strip



Fig. 14.54 Pedestrian Only



Fig. 15.01 Left Hand Curve



Fig. 15.02 Right Hand Curve



Fig. 15.05 Right Reverse Bend



Fig. 15.08 270 Degree Loop

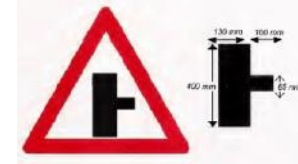

Fig. 15.09 Side Road Right

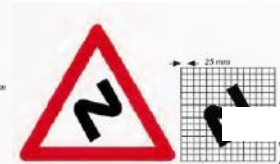

Fig. 15.07 Series of Bends



Fig. 6.17 Cycle Parking



(a)



Parking for differently abled

Source: IRC 67:2012, code of practice:signages by MoUD, 2012

4.8 ROAD MARKINGS

Road Marking is an essential element which is required for improving efficiency of the street.

Markings should strictly adhere to:

- IRC 35 – 1997 for road markings
- MoUD IUT Code of Practice for Road markings

Road Markings are done in following ways

- Line – Center line, Dotted line, Stop line etc
- Arrows – Straight, left, right, U-Turn, round about
- Word – STOP, BUS WAY, CYCLE LANE etc
- Diagram – Cycle, utility box, bus box etc.

Paint Markings : Paints used for road markings should be hot applied Thermoplastic paints instead of ordinary paints, for better visibility and long life. Visibility at nights is improved by the use of minute glass beads embedded in the pavement marking material to produce a retro reflective surface.

Plastics : Cold rolled or glued down plastic strips with adhesive at the back are used for cross walks / Zebra strips. This product is heavy-grade material with reflective beads embedded in the plastic. This method is used to mark the stop lines on bituminous roads in high density urban areas.

Epoxy technology has become more affordable and reliable. This material competes directly with plastic with respect to usage and cost.

Cats eye are reflectors which either reflect the light falling on them or can have a blinking mechanism at important locations.

Reflective Posts – These are plastic posts usually painted in red, fluorescent orange or yellow color and are fixed with bolts. They can be temporary or fixed based on the requirement.



General Recommendations:

- Signage should be predominantly placed such that it does not create any hindrance but is clearly visible to road users.
- Signage should not be installed within footpath walking zone but only at edge of footpath such that vertical clearance below lowest point of signage would be minimum 2.4m.
- It should be placed on the left side of the road and perpendicular to the line of the approaching traffic.
- Minimize sign board clutter by locating multiple, related signboards on single pole..
- Placement should be such that it is not in conflict with services and trees on roads. MUZ if provided is a good location for placing signage.
- Signage should follow uniformity as regards design and pattern for various types of signage so that those are easily identifiable and readable by the road users.
- Signage should be maintained as regards painting and installations so that they are readable and should be well illuminated.
- It is advisable to follow a pattern of placement for locating the directional signs. It is recommended to place direction signage at definite points near transit stations, bus stops and public buildings.
- Signage should be of larger size and font so that it is visible and readable even when vehicle is moving at speed.

Design Recommendations

- The design, colours and fonts of signage have to be in accordance with IRC 67-2012 .
- IRC has listed 47 mandatory signs, 60 cautionary signs and 68 informatory signs. These have to be appropriately used as per the requirement.
- Signage should be placed ideally in shoulders or parking spaces or MUZ. If placed on footpaths they should not obstruct pedestrian flow or access to properties.
- Gantries and signboards for bus stops/information signs should not obstruct footpaths.

There are two types of road markings.

- Non Mechanical Markings – Paint Markings, Plastic and Epoxy Markings
- Mechanical Markings – Cats Eye, Reflective posts.
- Road Markings are done in four basic colors.
 - White – used for permissible, informative
 - Yellow – used for preventive, cautionary
 - Blue – Special purpose marking
 - Green – Non Motorized Transport markings.

Following are the basic elements of road markings.

1. White Broken line – represents travel lane to be marked with lines 100 mm wide, 1500m long with 300 mm gap.
2. White solid line – represents boundary of carriage way to be marked with line 150 mm wide
3. Yellow solid line – right edge of carriageway to be marked with line 150 mm thick. If the center line is to be treated as a virtual divider, where only emergency response vehicles are allowed to cross it to access properties on the other side, there should be a solid double yellow line in the center of the road.
4. Directional arrow – represent change in direction, marked near turnings.
5. Channelizing line or Chevron marking – represent merging or demerging of lanes
6. Zebra crossings for pedestrian crossing to be marked with lines 500 mm wide, 2000 – 4000mm long with 500mm gap.
7. White colour line 100mm wide located 2m before zebra crossing at intersections for vehicles to stop.

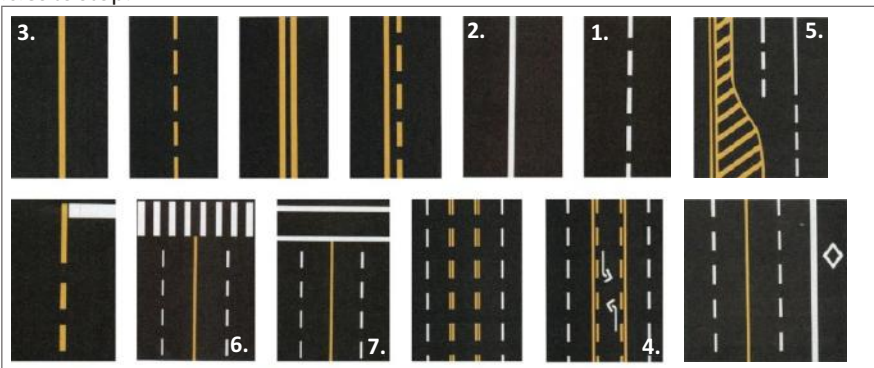

- Triangular yield marking at speed humps / speed tables – Elongated triangles
- Parking strips – parking for 2 wheelers, cars, buses, autos, cycles etc marked clearly on edge.
- Bus Box, bus lane, - to demarcate position where buses should stop or travel.
- Cycle symbol , cycle box – to demarcate clearly cycle lane and box where cycles should stop.
- Rumble strips – undulations to cause vibrations cautioning drivers to slow down
- Cats Eye – retro reflective objects fixed on street to highlight center-line, edge at night time.
- Reflective posts – to caution the driver regarding any obstruction on street.
- Word symbols – clearly mentioning no parking, bus lane, cycle lane etc.



Cycle track marking at Diu



Source: IRC 35 – 1997 for road markings & UTIPPEC Guidelines.

4.9

ADVERTISEMENTS

Advertising on streets has become a necessity in today's marketing generation. Outdoor advertising is also a revenue stream for Municipal Corporation.

Advertising affects the aesthetics and safety of the street to a great extent.

General Recommendations:

- Advertisement boards should be placed such that it does not cause physical and visual obstruction to pedestrians, vehicular traffic as well as signage.
- No part of the structure should project on the carriageway, footpath or cycle track.
- The structure should not be detrimental to safety of the people, vehicles and adjoining property.
- Should not adversely affect the aesthetics and beauty of the city scape and the city in general.
- Advertisement boards should not be put up on compound walls and at street corners in a way that cross view of traffic is blocked and blind corner is formed.
- Advertisement boards may be located in MUZ or parking.

Placement and type of advertisement structure

Type of advertisement structure	Street widths	Size	Heights from ground
Ground structures (Boards)	ROW 45m and more	12m x 12m	Min 3.5m Max 18 m
	ROW 18m - 45m	9m x 6m	Min 3.5m Max 18 m
	ROW 9m - 18m	3m x 3m	Min 3.5m Max 18 m
	ROW < 9m	Boards are prohibited	
Unipoles	ROW 30m and more	9m x 9m	Min 3.5m Max 18 m
If placed on central medians	Should be placed at intervals of 50m	0.6m x 0.9m	Min 2 m

Source: PMC Sky Sign Jahirat Niyamavali 2010

Application of road marking elements

- MV Lane – Solid white and yellow lines, dotted white line, directional arrows, chevron markings, cats eyes, reflective posts, rumble strips.
- Bus Lane – Bus box, bus only lane in word, solid yellow and white lines, cats eyes, rumble strips.
- Cycle lane – Cycle lane marking should be in yellow color, Cycle symbol should to be in white color.
- Pedestrian crossing – Stop line, triangular yield marking, cats eye, reflective posts at edges of refuge islands.
- Parking- Solid white colour line if parking allowed, solid yellow colour line if parking not allowed.
- Near Intersections – Directional arrows, stop line, cats eyes, reflective posts, triangular yield markings, no parking markings.
- Before & After Fly-overs/ Subways – chevron markings, rumble strips, cats eyes, reflective posts, directional arrows.
- Important landmark – rumble strips, word markings like school ahead, hospital ahead, quiet zone etc.
- Road marking needs to have a very scientific approach. The road marking needs to be placed cautiously considering its usage and impact. eg : The zebra crossings should connect the refuge islands or lead to other end of street without hindrance. Duplication of road markings should be avoided. Old ones should be scrapped before marking new ones. Road markings should not convey any message which hampers the usage of the section of the street or access to the property.

- Should be placed such that it does not adversely affect the beauty and unique character of important places, landmarks, heritage sites, religious buildings and natural elements like river, hills, trees etc.
- Sky signs should not be placed near intersection i.e they should be placed beyond 50m distance from the 'STOP' line marked at the intersections of roads.
- Advertisement board should not be of a type (for example - very brightly lit, causing glare, moving & changing figures, running lines etc.) and at such location that it would divert attention of vehicle drivers causing unsafe conditions on road.

4.10

TRAFFIC SIGNALS

At major intersections, traffic signals grant right of way to various road users to move along or cross a street. This reduces chaos on roads and improves road safety.

The decision of whether a given intersection needs a traffic signal or not should be taken based on warrants provided by IRC:93-1985, "Guidelines on Design and Installation of Road Traffic Signals" or any more recent prevailing guideline by IRC.

➤ Length of signal cycle

The IRC Guideline referred to above suggests that the total length of signal cycle should be 120 s or less, that being the maximum acceptable delay for drivers and pedestrians.

➤ Pedestrian signals

Pedestrian signals should be installed at all pedestrian crossings at a signal-controlled intersection. It should be ensured that pedestrian signals are properly aligned with the zebra crossings, which should be provided at a location that is the most natural and convenient for pedestrians to cross the road.

➤ Timings of pedestrian signals

The minimum time duration of pedestrian signal phase provided to pedestrians to cross a stretch of road should be the higher of -

a) What is prescribed in the prevalent IRC guidelines
and

b) Time in seconds = $7 + \text{length of the crossing stretch in metres}$

(For example - if the single crossing stretch is 10m in length, pedestrian phase time duration should be $7 + 10 = 17$ seconds).

➤ No free left

Left turns at all intersections should be controlled by appropriate signal phase, which should be duly interrupted by a pedestrian phase of the prescribed duration. Left turn signals should not be "always green / amber". To overcome the misconception that a free left is allowed, there should be an explicit left red arrow to indicate to drivers that a left turn is not allowed at the moment.

➤ Pedestrian signals at mid block crossings

Mid block crossings should be controlled by signals at places with high pedestrian volumes. "Puffin" type signals should be used at such crossings, to ensure that pedestrians observing the pedestrian signal face also get a view of the oncoming traffic.

The signals at mid block crossings may be activated on demand by pedestrians if pedestrian crossing volumes are moderately high, or could have predetermined cycles if pedestrian crossing volumes are very high.

➤ Location of signal poles

The prevailing IRC:93-1985 prescribes secondary signals, which are located on the far side of the intersection. This encourage vehicles to encroach on the zebra crossing provided for pedestrians, as the driver can still see the signal even after going beyond the primary signal.

If any revision or substitution of the said IRC guideline removes the prescription of secondary signals, they should be immediately removed in the city. Additional primary signal faces should be added as needed.

The prevailing IRC:93-1985 prescribes that the signal faces be placed as follows:

- The primary shall be at the near side of the intersection at the stop line on the left side of the approaching traffic.
- The secondary shall be on the far right of the intersection, or at the median island if available.

In addition, vehicles turning left should have a secondary signal face on far left side of the intersection. This signal face should have green, amber and red left turn arrows, so that the end of right of way for left turns can clearly indicated to drivers, e.g. when the corresponding pedestrian phase is about to begin. While adhering to these recommendations, special attention should be given to intersections where approaching arms have a bend. In such cases the location of the signal poles may have to be modified to ensure that the signal faces are visible to oncoming traffic. Additional primary or secondary faces should be considered to address the issue when required. Both primary and secondary signal faces should be visible from a distance of 90m.

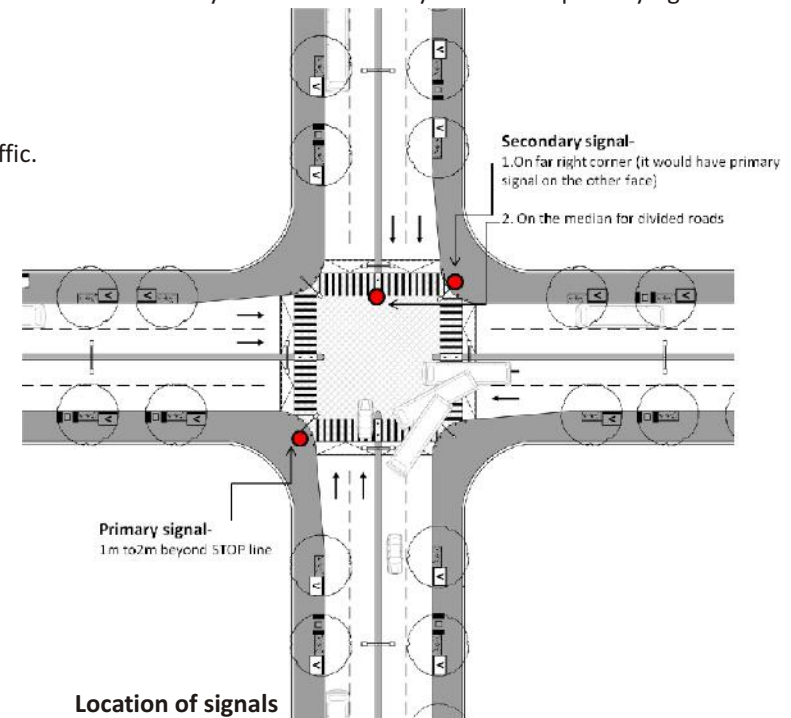

➤ Special signals for BRT and cycle lanes

All considerations applicable for determining the location of regular signal faces are applicable to such special signals also. Signals meant for BRT lanes should also be visible to vehicles in adjacent parallel lanes from a distance of 90m.

➤ Synchronizing pairs of signals on BRT corridors

As shown in diagram below, some BRT corridors may have two zebra crossings to approach the BRT stations. In such cases, both crossings should be controlled by their own signal faces, for vehicles as well as pedestrians. The pairs of signal faces for vehicles should be synchronized to ensure that vehicles coming at the upstream zebra crossing do not have a green signal unless the Downstream signal is also green.

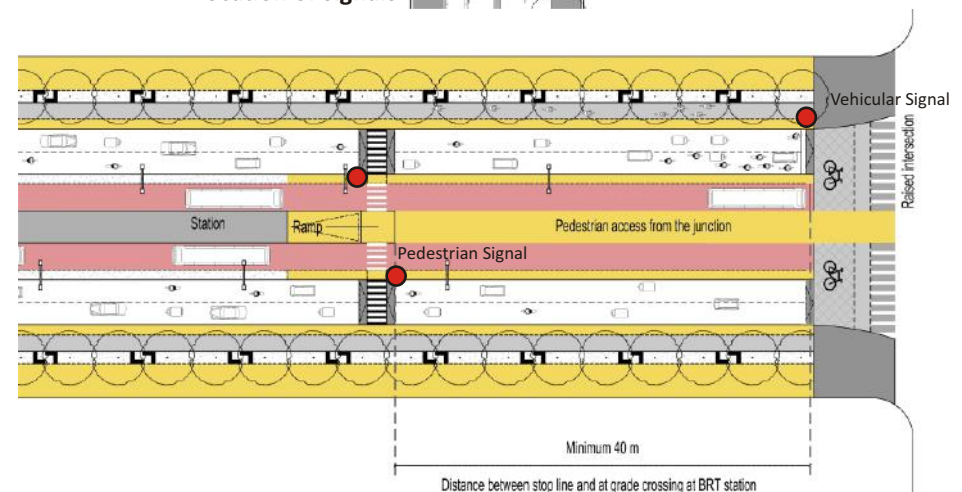

Station access from two pedestrian crossings



Plantation

Utility and services

Storm water management

Garbage containers

Public toilet

Streets to reduce impact on natural and built environment.

Multi utility zone

Includes introduction to elements, design recommendations based on standards and norms for all such street elements affecting the environment of the city.

5.1

MULTI UTILITY ZONE

- MUZ is a new and highly appreciated concept which has been successfully implemented in the city of Nanded in Maharashtra.
- Taking its cognizance the latest IRC for pedestrians 103 – 2012 and the Urban Street Design Guidelines for Delhi have made it as a mandatory element on Urban streets.
- The concept is very simple and workable. All the stationary elements on the street are organized in a dedicated space which results in obstruction free streets.
- Stationary elements like trees, hawkers, bus stops, underground and overhead utilities are organized in a space on shoulders between footpath / cycle track and motor vehicle lane.
- This concept has brought in high efficiency and improvement in streets.

A MUZ will have space provisions for following functions:

- Bus stops
 - Tree plantation
 - Street furniture
 - Auto Rickshaw stands
 - Parking
 - Hawkers
 - Public toilets, information kiosks
 - Underground and overhead Utility services like Electricity, Water, telephone, gas etc.
- MUZ is recommended on all streets based on the character of the street as recommended in USDG reference template.
 - The surface of MUZ shall have removable pavement or have green cover but has to be demarcated by curb stones.
 - Location of common utility ducts and duct banks should be coordinated with the location of plantation so that trees are not required to be disturbed during repairing and maintenance of service lines.
 - Demarcated spaces for 2W and 4W parking, hawkers, bus stops, trees, signage, utilities etc have to be done by activity mapping, surveys and stake holder consultations.
 - All activities and stationary elements like hawkers, trees, bus stops, parkings, kiosks, temples etc need to be mapped. All underground utilities need to be mapped in order to shift them over or underneath MUZ. After doing this the MUZ has to be designed.



MUZ for streets in Nanded.

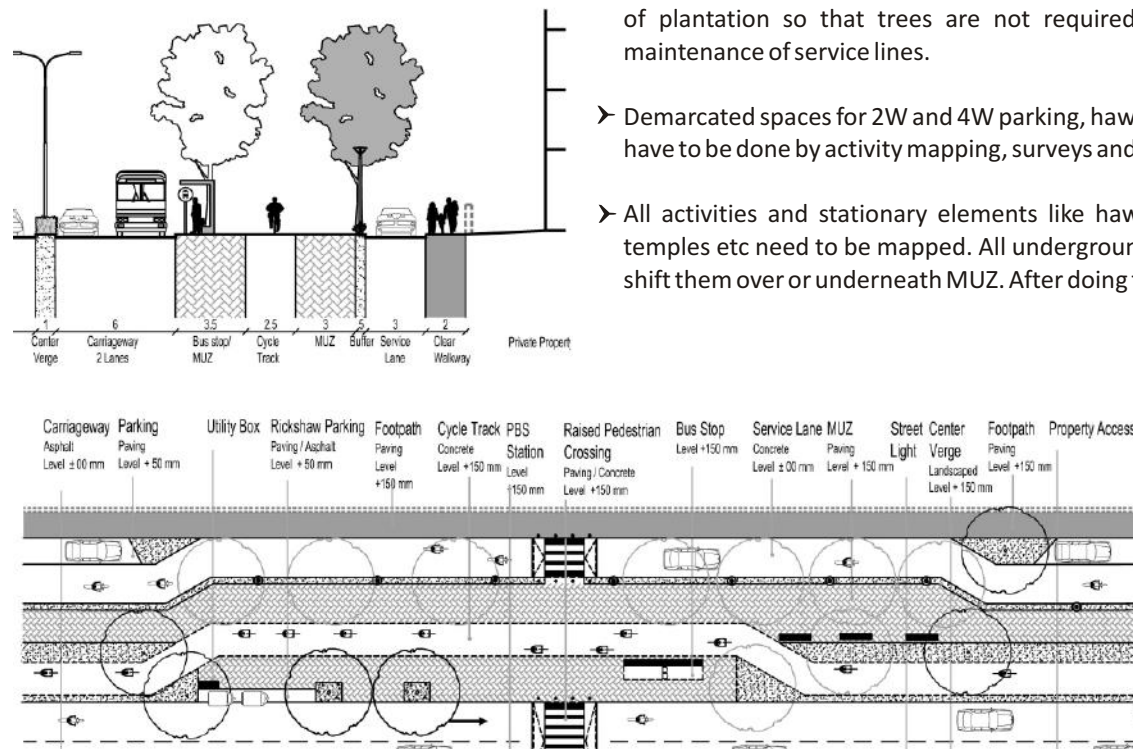

A typical MUZ

5.2

PLANTATION

Trees play an important part in the design, function, and aesthetic success of the street scape.

Trees are essential on streets for following reasons:

- To provide shade to road users especially, pedestrians and cyclists.
- To reduce local ambient heat and provide cooler atmosphere.
- Improve quality of air by absorbing pollutants.
- To reduce surface water drain off.
- Make streets aesthetically pleasing.

Trees along sides of the street are desirable to frame the street and enhance pedestrian movement.

Following are broad level recommendations for planting trees on streets:

- Trees should not obstruct the pedestrian flow or vehicular flow. Clear walkable footpath should be available depending on the road width.
- Street trees should typically be upright and branched above 2.4m to provide adequate walking clearance under branches.
- It is recommended to plant trees in Multi-utility zone as recommended by IRC codes.
- In case of narrow streets and in absence of Multi-utility zone, trees should be planted in parking zone / shoulder as it is advisable that trees utilize parking space instead of compromising walking space.
- It is mandatory to have tree pits which provide space for tree growth. Tree pits can be individual, elongated or connected. They may be surfaced with porous pavers, or grates that allow water to readily flow to the root zone. Minimum tree guard dimensions should be followed as per table mentioned in this chapter.
- Thorny plants should not be planted in the median.
- Plantation at edge of footpath (even within private premises) should not be of a type which would overgrow and spread on to the footpath blocking pedestrian path.



Trees should be only planted in following areas:

- Along the edge of the carriageway ideally within an unpaved areas (verge) between footpath and carriageway.
- MUZ wherever provided.
- Verge between footpath and cycle tracks.
- Within parking belts.
- Within frontage zones on commercial streets

Selection of species

Selection of species will be determined by following factors:

- Road width
- Available space for planting
- Adjacent land use and type of surrounding activity.
- Ease and cost of maintenance

Appropriate tree species selection should consider:

- Form, mature size, color, and texture to reflect the urban design goals of a street
- The mature tree canopy with respect to how it may affect street and pedestrian lighting or views of signage and building fronts
- The potential for root systems to affect sidewalks, curbs, and utilities
- Impacts and constraints created by local climate.

Generally following aspects should be considered while selecting species considering the adjacent land uses-

- Trees with columnar form are appropriate for narrower planting spaces such as small streets, alleys, and narrow medians.
- Trees with overarching canopies and medium density foliage are appropriate on wider streets, such as mixed use streets, throughways, and boulevards.
- Medium-sized trees with light to medium density foliage are appropriate on neighborhood residential and commercial streets.

Schematic representation of typology of trees

Ref : International Best Practices, Interaction with Landscape architects

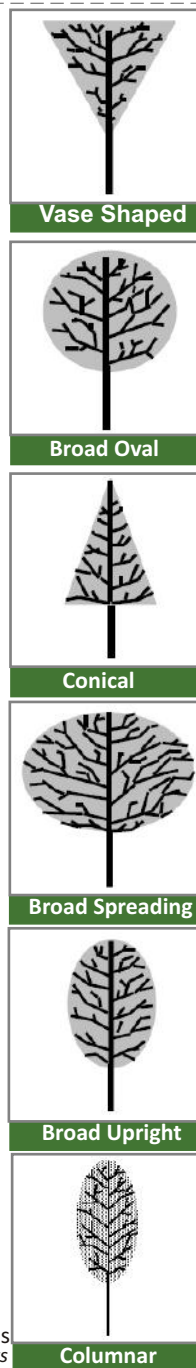

Cast iron tree grate



Concrete tree grate

Diameter of Tree Trunk	Min size of tree grate(M)
Upto 0.15m	0.6 X 0.6
Upto 0.3m	0.75 X 0.75
Upto 0.9m	1.5 X 1.5
Upto 1.2m	2 X 2

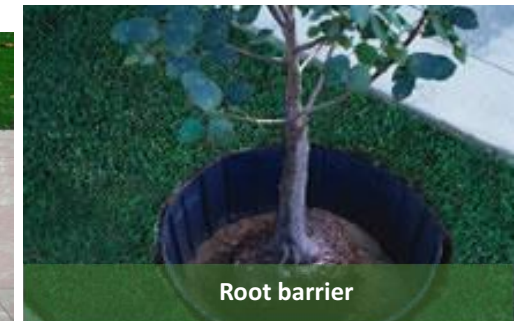

Root barrier

Local Indigenous trees ,Deciduous & Evergreen trees that are recommended by PMC Garden department and mentioned in PMC ESR 2013 should be planted. **Trees like EUCALYPTUS, Australian Acacia, Lantana, Lucena, Mast Tree (False Ashoka) should be avoided. Tree grates and tree guards should be provided for safeguarding trees**

Type of Tree	Location on street	Size of Tree guard (M)
Columnar, Conical	Shoulder	0.6 X 0.6
Columnar, Conical, Vase shaped	MUZ	0.6 X 0.6
Columnar, Conical, Vase , broad upright	Parking / Shoulder/MUZ	0.6 X 0.6
Broad Upright, Broad Oval	Parking / Shoulder/MUZ	0.75 X 0.75
Broad Upright, Broad Oval, Broad spreading	Multi-Utility Zone /Parking / Shoulder	0.75 X 0.75
Broad Upright, Broad Oval, Broad spreading	Multi-Utility Zone /Parking / Shoulder	0.75 X 0.75
Broad Upright, Broad Oval, Broad spreading	Multi-Utility Zone /Parking / Shoulder	1 X 1
Broad Upright, Broad Oval, Broad spreading	Multi-Utility Zone /Parking / Shoulder	1 X 1
Broad Upright, Broad Oval, Broad spreading	Multi-Utility Zone /Parking / Shoulder	1.5 X 1.5
Broad Upright, Broad Oval, Broad spreading	Multi-Utility Zone /Parking / Shoulder	1.5 X 1.5
Broad Upright, Broad Oval, Broad spreading	Multi-Utility Zone /Parking / Shoulder	2 X 2

Recommended location and placement of trees on streets.

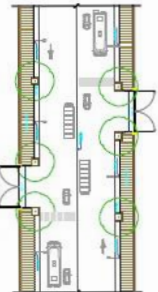
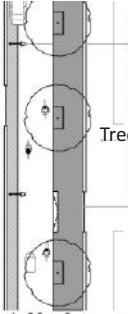
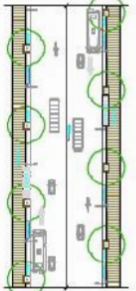
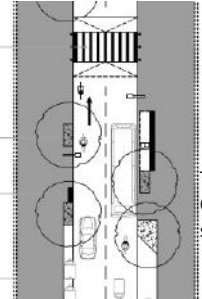
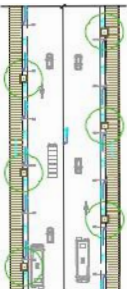
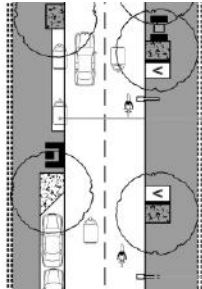
WRONG	RIGHT	DESCRIPTION
<p>Tree Plantation and access to building / property</p> 	 <p>Tree Plantation</p> <p>Property Access</p>	<p>Tree plantation should not obstruct pedestrians or vehicular access to any building or property at its entrance. Also footpath should be continuous.</p>
<p>Tree Plantation and Bus stops</p> 	 <p>Tree Plantation On the downstream side of bus stop</p>	<p>New Trees should be planted near the bus stop or downstream side of the bus stop in such a way that they do not obstruct the visibility of bus driver or passengers.</p>
<p>Tree Plantation and Street lights</p> 	 <p>Street lights and trees in staggered manner</p>	<p>New Trees should be planted in an alternate & staggered way with the street lights in such a way that street light does not get hidden due to tree canopy</p>

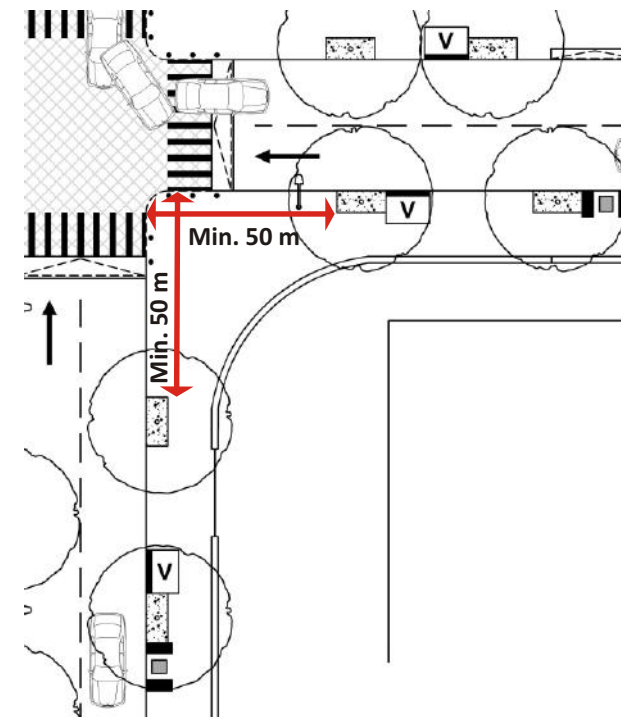

Recommendation for plantation at intersections
New trees should be planted no closer than 50m from major intersections.

Recommendations for plantation with respect to property access, street lights and bus stops

Existing trees on carriage way:

At some locations it is seen that existing trees occupy space on carriage way. They are either on edge or in between the carriage way. These need to be highlighted with Chevron road marking, cats eyes and reflective posts so that they are visible in night. This way accidents can be avoided. If possible they should be shifted to the edge making sure their life & growth is not hampered.

5.3

UTILITIES AND SERVICES

Streets are not just movement corridors for people and vehicle but they also carry infrastructural utilities. Utilities are the most crucial components of the street and require proper design, placement, & maintenance. The entire health of the city depends on these utilities and hence these need to be studied in detail and dealt with properly.

Streets carry number of utilities. Each utility service is installed & maintained by different departments and need to co-ordinate with the road department of Pune Municipal Corporation for installation / up gradation or maintenance.

Water Supply – PMC water supply Dept, Irrigation Dept

Sewerage – PMC Sewerage Dept.

Electrical supply - MSEDCL

Storm water drain – PMC SWD Dept.

Telecommunication lines – MTNL, BSNL, Reliance, Airtel, Idea etc

Gas lines – MNGI, ONGC

Cable TV

CCTV, Signals, Street lights, ITS etc – PMC Traffic Department and Traffic Police.

Each utility line has its peculiar requirements. These lines need to co-exist on streets in proximity but without affecting each other. The entire life cycle of the street depends on the design and placement of utilities.

General design recommendations

- Utilities should be ideally placed below verge between pedestrian path and carriage way or in MUZ if provided.
- Manhole covers and other obstructive utilities should be located within the edge zone of the sidewalk so that it does not disturb the pedestrian flow.
- Utilities should not be located below the carriageway.
- Alignment of the electric meters, feeder pillars should be as shown in the figure on right and should be placed such that there is adequate clearance for pedestrian movement.
- Manhole covers should be flush with the surface so as to have minimal level difference.

- Utilities need to be mapped scientifically and their records should be maintained. Technologies like GPRS (Ground Penetrating Radar Systems) should be used.
- Utilities should be laid Underground. Electrical LT & HT lines, Cable TV lines, Fiber Optic Cables etc should be properly taken underground.
- Storm water drains need to be covered and be along the Curb of footpath or Multi-utility zone. Open jalis should be avoided.
- Utility covers should be designed in such way that they are not easily recognizable but should carry the required information like utility names, logos etc.

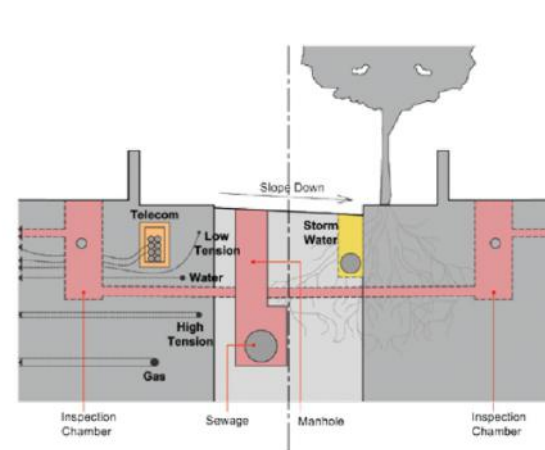

The placement of underground utilities should be coordinated with the location of street trees so that the trees are not disturbed if utilities are dug up for maintenance or replacement. Telecommunications, fresh water, and electricity lines generally can be accommodated within a 1.5–2 m wide area at the edge of the right-of-way. Sewage and storm water lines are usually placed closer to the center of the cross section.

Placement of access boxes for underground utilities

Access boxes for underground utilities should not constrain the space needed for through movement. If it is not possible to place utility boxes on private easements, the ideal location is in line with tree pits, to avoid conflicts with pedestrian movements. If there is no way to avoid placing a utility box in the pedestrian movement zone, then it is essential to orient the box parallel to the street. Placing the box perpendicular to the street, where it stands directly in the way of pedestrians, is unacceptable.

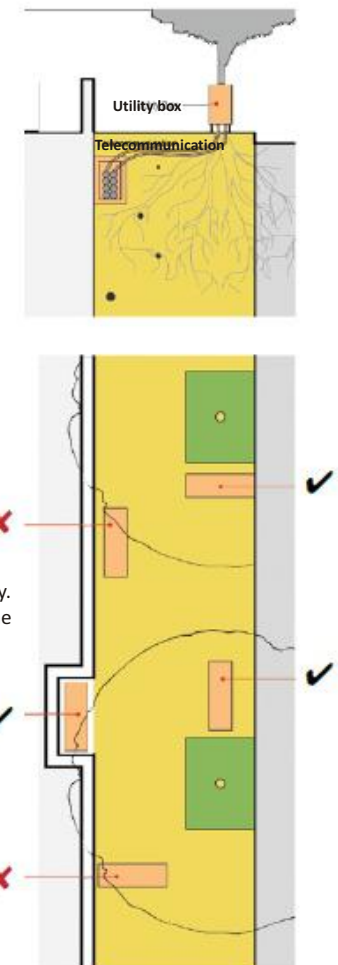

Ref : Better streets, Better cities, ITDP

General Design Recommendations

- Utilities need to be designed in such way that there will be less need for maintenance and future provision will be ensured.
- Sewer and Drainage lines require gravitational flow and are placed at substantial depth based on longitudinal slope.
- Storm water drains also work on gravitational flow but are placed along edge of road and right edge of footpath.
- Water Supply, Electricity, telecom and Gas lines work on pressure so slope is not required but as they have interactive properties need to be away from each other.
- Gas lines & Electrical lines need to be away to avoid accidents in case of leakage.
- Water supply lines need to be foolproof to avoid leakage and short circuit.
- HT Electrical lines and telecommunication lines should not be close to avoid possible electrical interference due to induced voltage.

Following are the recommended depths of Utilities

- Trunk Sewer line – 2 to 6 Meters
- Water supply service line – 0.6 to 1 meter , water supply trunk line – 1 to 1.5 meters
- Electrical cables – LT – 0.6 to 1 meters, HT – 1.5 to 2 meters
- Telecommunication lines – directly laid – 0.6 to 1 meters, in concrete ducts – 2 to 3 meters.
- Gas lines / combustible materials – 2 to 3 meters

Following diagrams show the placements of utilities for various RoW.

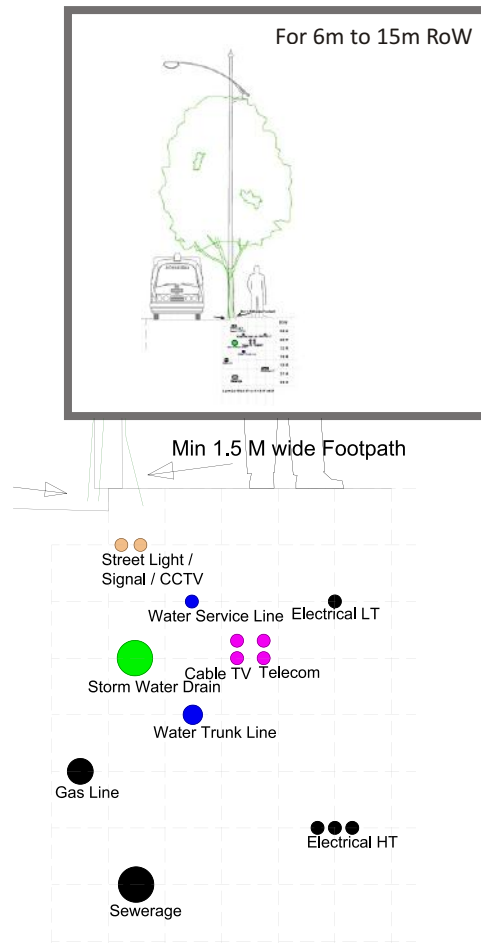

Placement of underground utilities for streets with RoW 6m to 15 m
Ref : CPHEEO Norms & IRC 98-1997 for Utilities

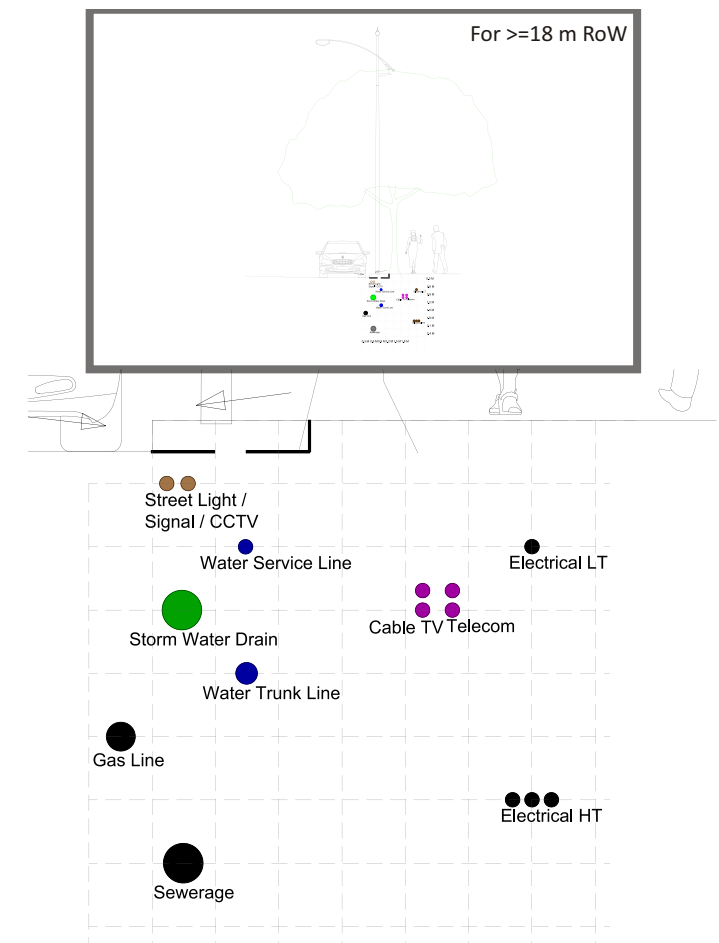

Placement of underground utilities under footpath or MUZ for streets with RoW 18 m or more than 18 m.

5.4

STORM WATER MANAGEMENT

- Generally storm water is collected across the edges of the carriageway by an inlet placed at regular intervals and directed into storm water drainage system.
- At present, the water is collected by the SWD pipes along roads and discharged into the nallas which further discharge the water into the river.
- Natural storm water management system is to be preferred for ecological reasons.

Pune Municipal Corporation has prepared a DPR for Storm Water management and has also addressed the issue in its Sanitation Plan 2010. 28 Basins have been demarcated and an extensive study has been done for storm water discharge.

- PMC needs to construct SW lines where ever those are absent.
- SW lines need to be along both sides of the street, ideally in the shoulder or the Multi-utility zone if provided.
- Care should be taken to follow the longitudinal slope of the street and water should not accumulate at the intersections.
- The street should have gradient on both sides towards the edge.
- Also the footpath to have gradient slope towards the shoulder so that water does not accumulate on footpaths or enters any property.



Permeable paving blocks



Permeable paving blocks



Bioswales



Unpaved verge along streets

Following are some of the elements which can help in natural draining of storm water and rain water harvesting-

- Unpaved verge along streets and unpaved areas below tree grating.
- Permeable paver
Pavers are brick-like materials that are manufactured in a variety of shapes. Pavers fit together like tiles and are set with small gaps between them, creating grooves for water to infiltrate the soil beneath. Other materials such as broken pieces of recycled concrete can be used. Paved walkways can also be removed and replaced with gravel or mulch.
- Bio-swales
Water is retained and gets infiltrated in the bio-swales reducing the storm water run off volumes and peak flows. Bio swales are connected to the main storm water drain either in series (connected only at the end) or on parallel connection. Bio-swales adjoining the storm water help to drain extra water which can overflow within the drain.)

General design recommendations

- Bio-swales are recommended along road side planting strips, within MUZs, within wide central medians and spaces created by grade separators.
- Minimum width of swales should be 1m and ideally run continuously along a stretch of the road.
- Permeable pavers should be used for parking belts and sidewalks and any other non-vehicular roadway in parts or in totality.
- SWD pipes need to be cleaned and de-silted on regular intervals, specially before the onset of monsoons.

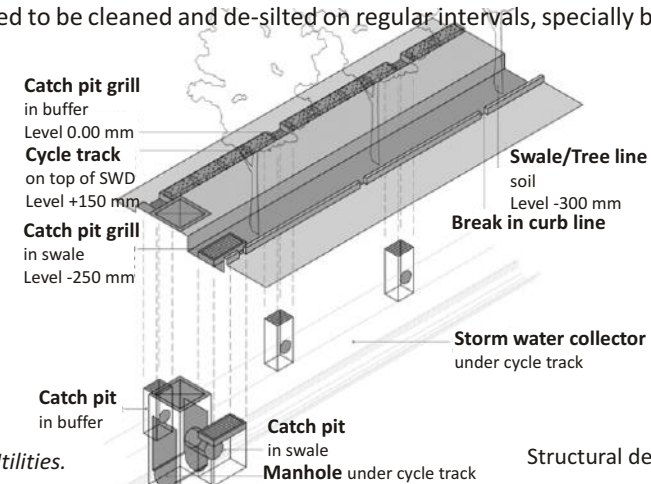

Ref : CPHEEO Norms & IRC 98-1997 for Utilities.

Structural details for bio-swales

5.5

GARBAGE CONTAINERS

Garbage bins at right places and at frequent intervals help to keep the streets clean. Clean streets not only are important for community hygiene but also encourage people to use streets for walking and socialising.

General Design Recommendations

- Garbage containers to be smaller in size and should be covered. Two or three small containers are preferred in place of a single big one. These are easy to maintain and will ensure regular replacement.
- Garbage containers should not be placed on footpaths or cycle tracks. They should ideally be placed in Multi-utility zone if provided. They can also be placed in parking space with proper platform created for its easy lifting.
- Two Garbage containers in a radius of 500m are advisable but care should be taken that they are not placed near hospitals, heritage monuments and important landmark buildings.
- The recommendations for augmentation of Solid Waste management given in Pune Sanitation Plan 2010 should be followed.



Door to door collection system is ideal method of waste collection to discontinue practice of garbage containers on streets.

Ref : PMC Sanitation Plan, SWACH & International best practices

5.6

PUBLIC TOILET

The provision of public toilets is a basic human right. Being able to access a toilet is a fundamental aspect of community development because it ensures that all people can move freely in their city and relieve themselves with dignity. The inability to use a bathroom, coupled with the smell of feces and urine detracts people from the streets. A study conducted in Chicago showed that when people have a concern about needing a rest room on the way to work, they will be more likely to take their cars than use public transit.

The American Restroom Association uses the term “rest room challenged” to refer to those who have to go frequently or at times urgently. These include people with an array of normal and medical conditions, the specially abled, pregnant women and parents with children, and the elderly and for whom the public toilets are very necessary.

General Design Recommendations

- 1 toilet block should be provided at every 1.5 km on mobility and feeder corridors. Public toilets should be provided near transit stations and off street parking areas.
- Public toilets need to be considered in the road design such that it is easily accessible and aesthetically integrated with the surroundings.
- Public Toilets should not obstruct footpaths, cycle lanes and carriage ways. If placed on edge of the street, min 2m wide clear walkway should be available. Public toilets should be placed within MUZ wherever provided.
- Care should be taken that public toilets are connected to sewerage lines and are kept clean. Sulabh or paid toilets are better maintained.
- Since public toilets are recommended at regular walkable intervals, the capacity can be reduced to minimize the overall dimensions of the block.
- Public Toilets can have an adjoining landscape portion where in plants which grow on urea can be planted.
- The design and access for Public toilets should be friendly for old people and specially abled persons.
- The recommendations for augmentation of public toilets given in Pune Sanitation Plan 2010 and public toilet policy of PMC 2016 should be followed.

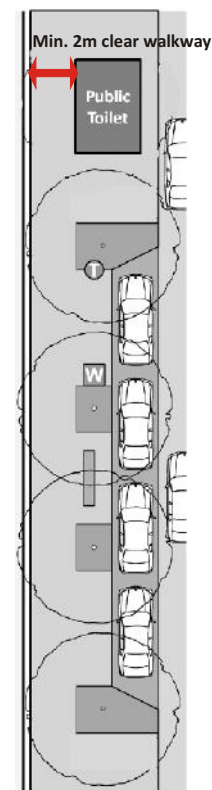

Placement of toilet block in MUZ



Universal Accessibility & Barrier Free Design

Provides for information and recommendations based on norms and standards for Specially abled friendly design to make streets of Pune accessible to all

6.1

UNIVERSAL ACCESSIBILITY AND BARRIER FREE DESIGN

Universal design is the design of products and environment to be usable by all people to the greatest extent possible without the need for adaptation or specialized design - Ronald L. Mace

The purpose of universal design is to address through design the needs of such people like elderly and people with special needs whose physical, mental or environmental conditions limit their performance.

Since streets are the common public spaces and most widely used by all people, it is necessary to design those on the principles of barrier free environment providing safety and support for people of all ages, genders and with special needs etc.

As per '*Persons with Disabilities (Equal Opportunities, Protection of Rights and Full Participation) Act, 1995*', a barrier free built environment is essential to facilitate the disabled.

One of the important objectives of USDG is to make streets and facilities on streets of Pune accessible to and usable by senior citizens and people with special needs.

Office of The Chief Commissioner for Persons with Disabilities, Ministry of Social Justice and Empowerment, Government of India has published a report in 2001 named '*Planning a barrier free environment 2001*' which describes in detail about the design requirements of people with special needs for access and movement within building and public places.

USDG considers the recommendations from the report and advocates referring the manual for any aspect related to barrier free design for streets and street elements for Pune.

Principles of universal design

In designing for inclusion, accessibility and barrier-free pedestrian environment following seven Principles of Universal Design are recommended:

Principle 1: Equitable Use

The design is useful and marketable to people with diverse abilities.

Principle 2: Flexibility in Use

The design accommodates a wide range of individual preferences and abilities.

Principle 3: Simple and Intuitive Use

Use of the design is easy to understand, regardless of the user's experience, knowledge, language skills, or current concentration level.

Principle 4: Perceptible Information

The design communicates necessary information effectively to the user, regardless of ambient conditions or the user's sensory abilities.

Principle 5: Tolerance for Error

The design minimizes hazards and the adverse consequences of accidental or unintended actions.

Principle 6: Low Physical Effort

The design can be used efficiently and comfortably and with a minimum of fatigue.

Principle 7: Size and Space for Approach and Use

Appropriate size and space is provided for approach, reach, manipulation, and use regardless of user's body size, posture, or mobility.

6.2

THE FUNDAMENTAL DESIGN REQUIREMENTS

People using wheelchairs, crutches, walkers, visually or hearing impaired have different requirements. The requirements of 2 main target groups of users has been considered below. The requirements of the senior citizens are similar to those considered for these particular target groups.

➤ For people with impaired mobility

- Thresholds and changes in level should be avoided.
- Ground and floor surface should be hard and even.
- For ambulant disabled people to move securely, ground and floor surfaces should be even and slip resistant.
- Obstacles, projections or other protrusions should be avoided in pedestrian areas such as walkways, corridors, passageways or aisles.
- Handrails should be provided on stairs and ramps.



Photo source: Citizen matters.in Bangalore
Footpath although wide is uneven causing inconvenience in using wheelchair

➤ For People with visual impairment

- Contrasting colors and warning blocks should be used to aid the identification of doors, stairs, ramps, passageways, etc.
- Surfaces can be varied to indicate pathway, change of directions etc.
- Orientation cues should be specially illuminated.
- Handrails can be used as a location aid.
- To minimize the risk of falls and injuries, hazards such as posts, single steps and projections from walls should be avoided.

Space allowances for wheelchair

- The minimum clear floor or ground area required to accommodate a single, stationary wheel chair and occupant is 900mm x 1200mm as shown in the figure.
- A minimum clear floor ground area of 1200mm x 1200mm would allow access for both forward and side approach.
- The minimum clear floor ground area for a wheelchair to turn is 1500mm whereas it may be ideal to provide 1800mm.

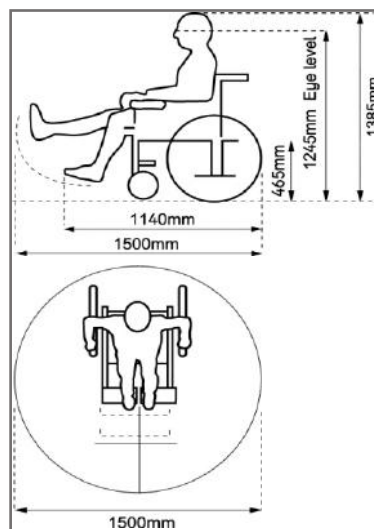

Space allowances for wheelchair movement

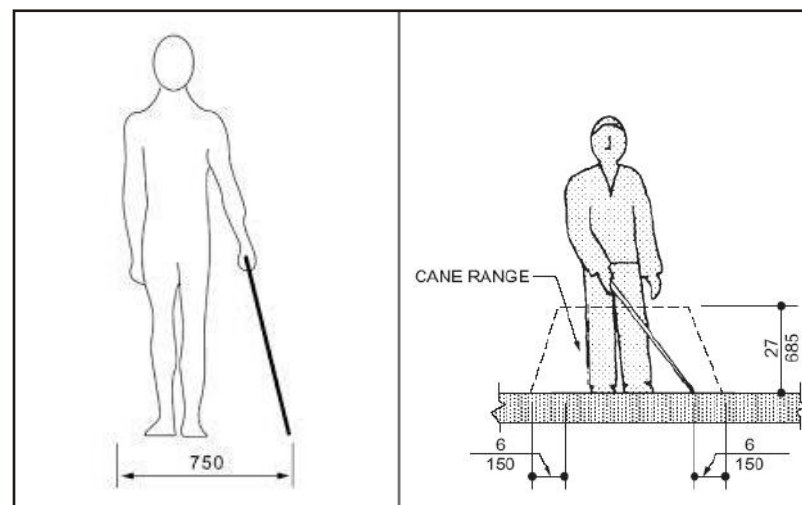

Detectable reach of a cane user
Space allowances: Most blind people in India use canes to navigate the streets.

A cane user will detect objects within a sweep that extends approx 150 mm (6") to either sides of his shoulders.

Source of images: Design for access and mobility-building and associated facilities, New Zealand Standard

6.3

SIDEWALK DESIGN

- Sidewalks should be continuous and should have stable, firm level and slip-resistant surface without any projections, drops, or unexpected variation in levels.

- It should have guiding blocks for people with visual impairment; and fitted with visual signs and tactile clues (e.g., Braille blocks) as route finders. It should have well defined edges of paths and routes by use of different colors and textures.

- Sidewalks should have curb cuts where-ever a person is expected to walk into or off the pathway with warning blocks installed next to all entry and exit points from the pathway.

Bollard

Where bollards are erected at entrances to walkways or pathways, one gap of 900mm should be provided between the bollards.

Grating

Grating located along the exterior circulation should preferably be covered. It should not have spaces greater than 12 mm wide in one direction. Longer dimension of the slits should be perpendicular to the dominant direction of travel.

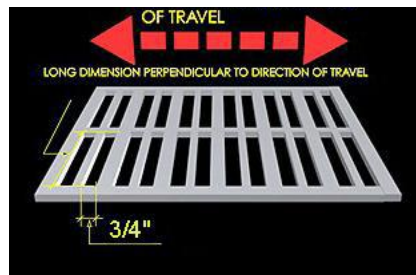
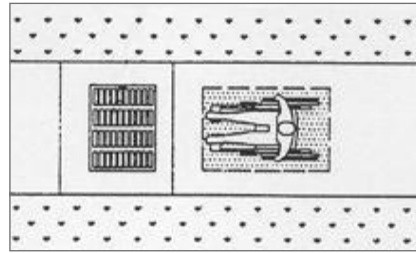

Placement of grating

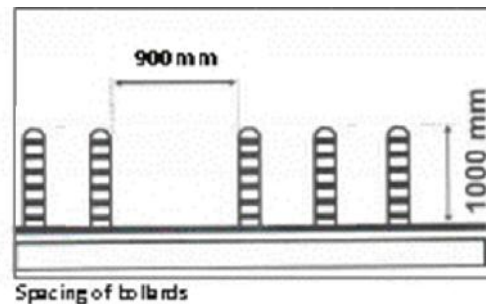

Spacing of bollards

6.4

TACTILE PAVING

- Tactile paving is a textured bright coloured tile which can be detected by a visually impaired person and provide guidance in using pedestrian area.

- Tactile paving should be provided in the line of travel avoiding obstructions such as manholes/tree guards/lamp posts etc.

- Tile should have colours which contrasts with surrounding surface.

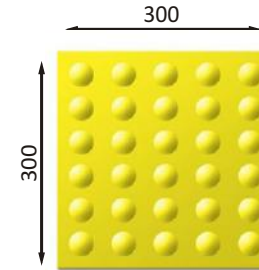

Dot-type block give a warning signal.

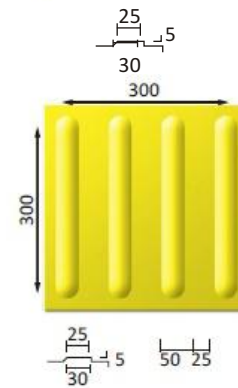

Line-type blocks indicate the correct route to follow



Recommended places and guidelines to install tactile paving for persons with impaired vision:

- In front of an area where traffic is present.
- In front of an entrance/exit to and from a staircase or multi-level crossing facility.
- Entrance / exits at public transport terminals or boarding areas.
- Sidewalk section of an approach road to a building.
- Guiding path from a public facility to the nearest public transport station.
- A distance of 600 mm is to be maintained from the edge of footpath or any obstruction to place warning blocks.
- It should be placed 300 mm before the beginning and end of the ramps, stairs and entrances.
- It should be laid 900 mm wide across the entire footpath where the crossing occurs.

6.5

CURB RAMP AND SLOPE RAMP

Curb ramps are critical for providing access between sidewalk and street for people who use wheel chairs. Curb ramps are most commonly found at intersections, but they may also be used at other locations such as on-street parking, loading zones, bus stops, and mid block crossings.

Design Requirements for curb ramp

- Curb ramps are provided where the vertical rise is 150 mm or less.
- It should have a slip-resistant surface and should not allow water accumulation near where the ramp begins and ends.
- It should not project into the road surface and should be located or protected to prevent obstruction by parked vehicles
- It should be free from any obstruction such as signposts, traffic lights, etc.
- The gradient of a curb ramp should not be steeper than 1:10.
- The width should not be less than 900 mm.
- Warning blocks should be installed at the end of the curb ramp to aid people with visual impairments.
- Curb ramps do not require handrails.
- Curb ramp at pedestrian crossing should be wholly contained in the area designated for pedestrians' use as shown in the figure

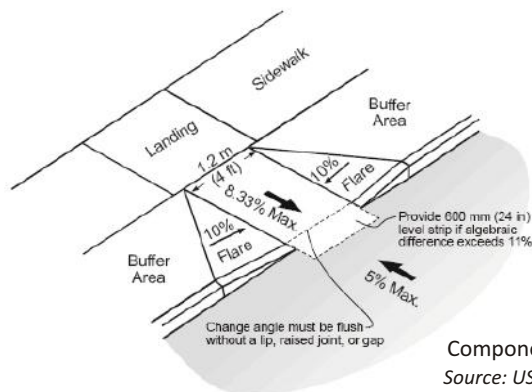

Components of curb ramp

Source: US department of transportation(www.fhwa.dot.gov)



Design Requirements for curb ramp

Curb ramps are usually categorized by their structural design and how it is positioned relative to the sidewalk or street. The type of curb ramp and the installation site will determine its accessibility and safety for pedestrians with and without disabilities.

- Built-up/Extended Curbs should not be used if they project into a roadway, as it is dangerous for users and obstructive for vehicles.
- Curb ramps should have flared sides where pedestrians are likely to walk across them and the gradient of the flared side should not be steeper than 1:10.
- Returned/Continuous Curb are an alternative approach that may be used where pedestrians will not be expected to walk across the ramp.

Slope Ramp

Where the vertical rise is greater than 150 mm, it should constitute a slope ramp and should comply with the standards recommended in the manual.

Where there is a large change in elevation that requires multiple ramps and landing combination, other solutions such as elevators should be considered.

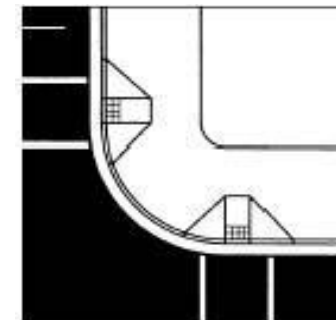

Perpendicular curb ramps with flare and level landing

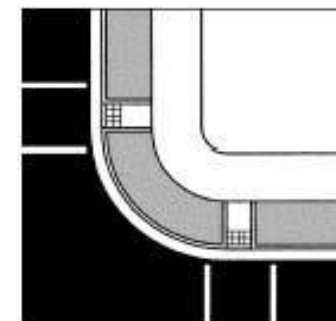

Perpendicular curb ramps with returned curbs and level landing

Alternatives for placement and type of curb ramps

6.6

UNIVERSAL DESIGN FOR INTERSECTION AND CROSSING

To facilitate safe and independent crossing of people with special needs, raised crossing and refuge islands are found to be effective.

Raised crossings join footpaths at the same level and make crossing streets convenient not only to people with special needs, but also for everyone else. Also raised crossing helps to reduce the speed of the approaching vehicles and gives the driver a better view of the people crossing streets.

Refuge islands help to reduce the length of the crossing and make it convenient and safe for user. Curb ramps are recommended at both sides of the raised crossings. Guide strips should be constructed to indicate the position of pedestrian crossings for the benefit of people with visual disabilities. A colored tactile marking strip at least 900 mm wide should mark the beginning and the end of a traffic island, to guide pedestrians with impaired vision to their location. Pedestrian traffic lights should be provided with clearly audible signals for the benefit of visually impaired pedestrians. Where pedestrians get right of way at different times for crossing roads in different directions, the audible signals should emit sounds at different pitch and beats. Push buttons should be tactile, easy to locate and operate and should be placed between 0.90 m and 1.20 m off the ground for the benefit of wheelchair users.

6.7

UNIVERSAL DESIGN FOR PEDESTRIAN GRADE SEPARATORS

Subways and overhead bridges should be accessible for people with disabilities. This may be achieved by:

- Provision of slope ramps or lifts at both the ends to enable wheelchair accessibility.
- Ensuring that the walkway is at least 1800 mm wide.
- Provision of tactile guiding and warning blocks along the length of the walkway.
- Keeping the walkway free from any obstructions and projections.
- Providing for seats for people with ambulatory disabilities at regular intervals along the walkway and at landings.

6.8

UNIVERSAL DESIGN OF TRAFFIC SIGNAL

- Pedestrian traffic lights should be provided with clearly audible signals for the benefit of pedestrians with visual impairment.
- Acoustic devices should be installed on a pole at every point of origin of crossing.
- The installation of two adjacent acoustic devices such as beepers is not recommended in order to avoid disorientation.
- The time interval allowed for crossing should be programmed according to the slowest crossing persons.
- Acoustical signals encourage safer crossing behavior among children as well.



6.9

UNIVERSAL DESIGN FOR STREET FURNITURE AND STREET SIGNAGE

Disabled persons may have limitations in the movement of their head, or a reduction in peripheral vision. Signs positioned perpendicular to the path of travel are easiest for them to notice. Persons can generally distinguish signs within an angle of 30° to either side of the centerline of their face without moving their heads.

Signs should be in contrasting colour and preferably be embossed in distinct relief to allow people with visual impairments to obtain the information by touching them. Audible signs should be installed in dangerous areas for the aid of people with visual impairments.

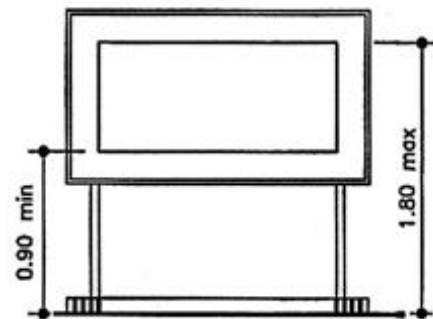
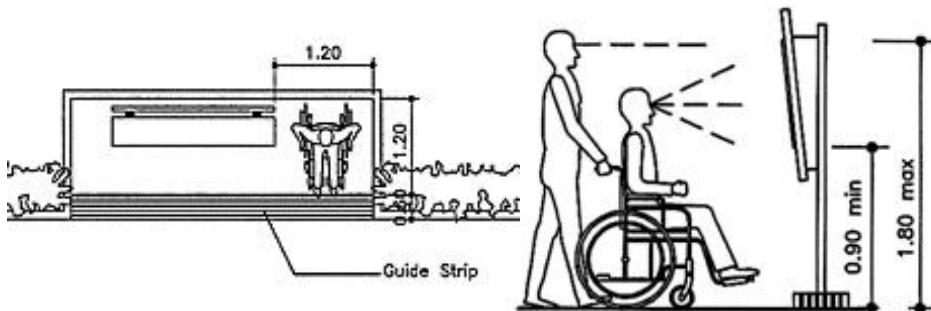

6.10

UNIVERSAL DESIGN FOR PUBLIC TOILETS

• A minimum of one toilet compartment should have enough floor space of 2000mm x 1750mm for wheelchair users to enter and exit.

• Provide a door of clear opening of at least 900mm with the door swing outwards or be folding or sliding type.

• The flooring should be slip resistant.

• Accessible toilet should have a switch near the WC (one at 300mm and the other at 900mm from the floor level), which activates an emergency audio alarm (at the reception/attendants desk, etc.)

Water Closet:

• WC should have clear space of not less than 900mm wide next to the water closet.

• It should be located between 460mm to 480mm from the centerline of the WC to the adjacent wall and have a clear dimension of 800mm from the edge of the WC to the rear wall to facilitate side transfer.

• The top of the WC to be 475-490mm from the floor.

• Grab bars to be provided at the adjacent wall and the transfer side of the WC.

• On the transfer side-swing away/up type and on the wall, side L-shape grab bars should be provided.

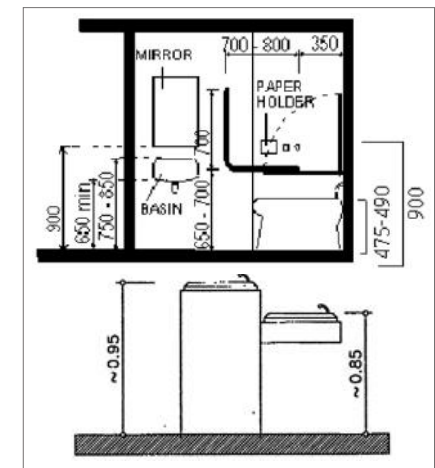
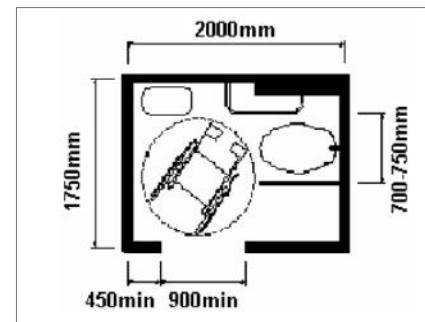

Size and layout for toilets and WC for persons with special needs

INTERSECTIONS

Provides for recommendations based on various aspects related to planning and designing of intersection considering the requirements of all stakeholders like pedestrians, cyclist, vehicles etc.

07

7.1

INTERSECTIONS

Intersections or junctions are the most important and critical components of any street. Any location on the street where two or more streets intersect each other are called intersections. These are to be designed taking into consideration Mobility, Safety and Environmental aspects. Junctions are the spaces where through moving, turning pedestrians, cyclists, vehicles, public transport share the same space. It is very important to design intersections for safety, and accessibility to all types of road users. Intersections in urban areas should be compactly designed and for low speed. Intersections are of various types but can be categorized into two main types namely planned and unplanned. In Pune city streets have evolved over the years with mostly unplanned intersections which pose unique challenges pertaining to land use and density. Performance of any street depends largely upon design and efficiency of its intersections.

Planning of Intersections -

Planning intersections requires a methodical approach. Following are the basic recommendations.

- First priority at intersections in urban areas should be given for pedestrian crossings and safety, then for public transport, bicycles and then for vehicles. Parking / Halting vehicles (Auto rickshaws, hawkers, buses, private vehicles etc) for min 50m on all arms of intersections on mobility & feeder corridors should be strictly banned.
- Two intersections should not be close to each other. A distance of at least 250M is recommended between intersections on Mobility and Feeder corridors.
- Intersections to be designed as compact as possible for low vehicle speeds and should have high visibility for pedestrians and turning traffic. Turning left should not have obstacles on corners which will obstruct the visibility. Direct access to properties from major intersections should be avoided.
- Low height shrubs only are to be planted at intersections as big trees or dense foliage obstructs signage and light.
- The Dirt spaces (spaces where no traffic movement occurs and so dirt is accumulated) should be reclaimed for pedestrians.
- Right of way or street hierarchy should change only at intersections. RoW and Street hierarchy should not change at mid block locations.

Design of Intersections -

Design of intersections depends on following factors.

Geometric Alignment – The angle in which number of streets intersect decides the geometry of intersection. This geometry plays an important role in deciding turning traffic and pedestrian crossing movement. Most Streets in Pune intersect each other in an organic manner forming acute angles or skewed intersections. Improvement in the geometry of such locations should be worked out.

Right of Way – Generally users from wider road arm approaching the intersection get higher priority. Deciding optimum width for through traffic, turning traffic, pedestrian and cycle flow depends largely on available right of way. The possibility of widening the intersections to an optimum right of way should be checked.

Land use – In a city like Pune, land use plays a very important role in intersection design. Having many openings to adjoining properties like schools, temples, hospitals, offices, markets etc from major junctions affects the performance of junctions. Such access to properties must be planned or diverted in such way that performance of junction will be improved.

Traffic count – The relation between volume of traffic (through traffic and turning traffic and also pedestrian count) and capacity of street (available space) decides the managing criteria of any intersection. Opting for signalized / non signalized / round about or grade separators largely depend on this factor. While designing any intersection the traffic flow count, pedestrian count and overall network analysis should be done. Applying design concepts which will reduce the pedestrian vehicular conflicts should be applied.

Natural / Artificial topography – In most of the cases the topography influences the design. Having slopes and gradients affect the speeds, safety and utilities near intersections. Design of Intersections should take the topography in account and ensure that vehicle speeds are controlled and vehicles are not required to halt on sloping surfaces like ramps etc, pedestrian crossings are safe, water does not get accumulated but gets drained out easily.

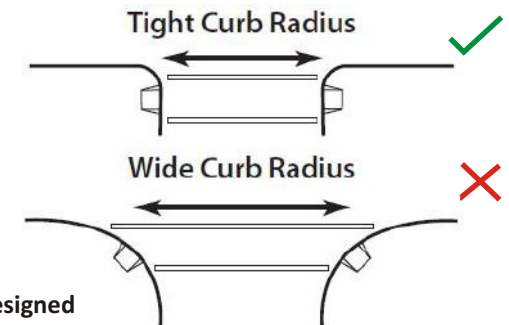

Intersections should be compactly designed to make them safer for pedestrians and cyclists.

Intersection Design for Pedestrians-

Ensuring Pedestrians safety is the most important aspect of intersections design. Pedestrians are most vulnerable to conflict with vehicles and hence their safety in crossing streets at intersections should be given the topmost priority in design.

Following are the pedestrian safety elements required to be introduced at all intersections.

Curb extension – maximum pedestrians cross the street from intersections. In order to facilitate their waiting and reduce the distance for crossing the curve portion of footpath at intersections should be widened. This helps in creating extra space, avoids vehicles halting at intersections, improves visibility of vehicle drivers and pedestrians.

Smaller turning radius – Curb extension may not be possible in every case, especially at congested intersections. Where curb extension not possible, smaller turning radius should be provided to slow down vehicles taking the turn. This would provide safety for pedestrians crossing the road.

Refuge Islands - Refuge islands should be developed at the center of the two way street so that pedestrians cross the stretch in safe stages.

Channelizers – The triangular spaces formed at right and left turning lanes at intersections should be reclaimed for pedestrians as vehicles do not use them and mostly dirt gets accumulated there. Such triangular spaces are channelizers. They should be accessible to pedestrians as refuge spaces.

Bollards and railings should be provided for footpaths at strategic locations in the vicinity of junctions to prevent vehicle movement on footpath and to ensure that pedestrians can cross only at designated crossing points.

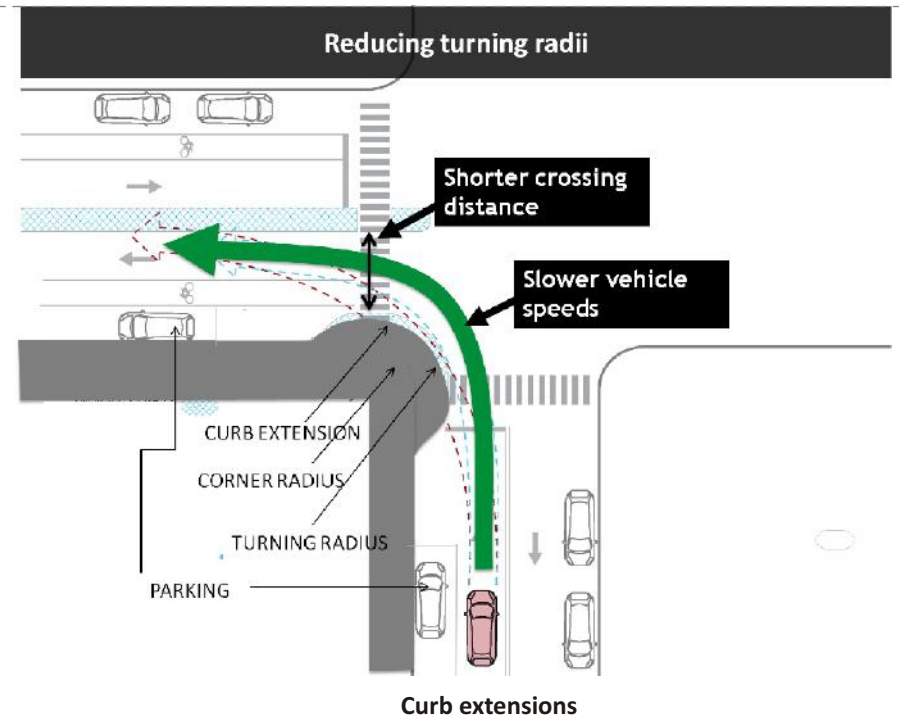

Traditional Approach vs. Safety for all approach in designing turns

Graphic on left shows a typical slip lane with a simple radius turn and an island at about 45 degrees. Graphic on right shows the same slip lane, but the curve is now compound. The island is roughly at a 30 degree angle.

Design by Michael Wallwork

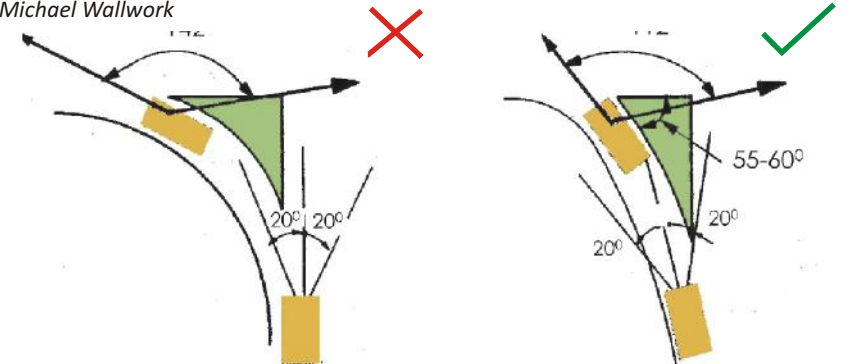

high speed
low visibility

low speed (23-29 km/h)
high visibility



Refuge islands



Channelisers

Disabled friendly access to footpaths – Footpaths should have ramps with slope of 1:10 m with bollards on sides so that people can easily climb up and vehicles cannot enter.

Continuous Zebra crossing – Zebra crossings should have sufficient light and be paint marked clearly from edge to edge connecting refuge pedestrian spaces. Stop line to have reflective cats eye fixed on them to improve the visibility and define the street crossing.

Intersection Design for Cyclists-

It is preferable that continuity of cycle tracks be maintained up to road intersections by using appropriate techniques. Only if this is not practically possible on mobility corridors considering limitations of intersection design, cycle tracks can be merged with the traffic lane before a major intersection at minimum possible distance of up to maximum 50m.

Merging – demerging cycle lane – Cycle Tracks provided on Mobility streets need to merge with the traffic lane before the stop line. This is required for cycles turning to other street. If possible left turning cycle lane can continue to be dedicated.

Paint marking cycle priority lane - Places where dedicated cycle lane merges with the regular traffic lane near the intersection it needs to be paint marked to distinctly remind vehicles of cyclist priority. Paint marking to be minimum 1.5m wide along curb side and be marked in green /blue color.

Paint marking cycle box – A cycle box must be painted before the zebra crossing so that cyclist get priority in front and can safely change the lanes. Vehicles to stop before cycle box. Width of cycle box to be min 2m.



Cycle lanes at intersection



Paint marking cycle lane



Cycle box

Ref: Int Best Practices, IRC 1994 , IRC 103-2012.

Intersection design for vehicles -

It is very essential to design intersections in Urban areas for low vehicular speeds. Intersections should be freed from obstructions like parked vehicles, hawkers etc on mobility and feeder streets for at least 50m. Intersections are Signalized or non signalized.

Following are the recommendations for Signalized intersections-

Turning lane –

While designing for intersections, traffic and turning vehicle counts should be taken. At intersections where there is heavy left / right turning traffic an extra lane for turning should be taken from other half of the street. This extra lane should be for at least 50m from stop line. Mere widening the intersections without thought given to turning traffic will cause bulb effect and traffic saturation.

Clear lane marking -

Street section near intersection should have clear signage and street marking showing straight going arrows, turning lane arrows, stop line etc. Movement of turning vehicles should be guided after considering presence of safety elements like medians and refuges.

Position of signals –

Refer to chapter no. 4.10 for details about placement of signals at intersections.

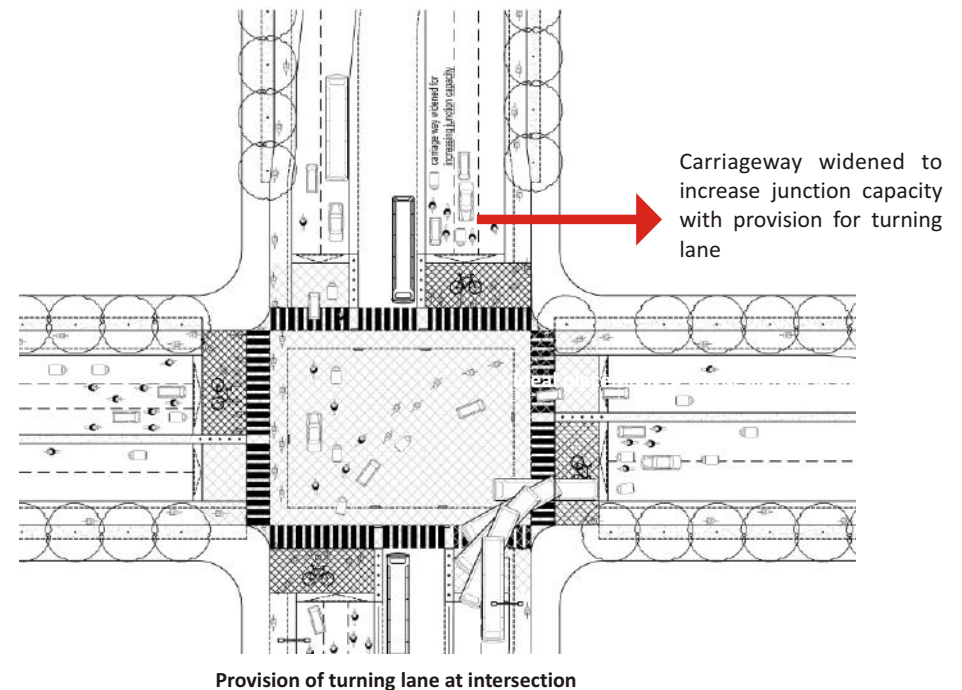

Intersection Design for Vehicles-

Traffic rotaries and roundabouts are effective ways of managing the intersections without signals. Roundabouts work well in situations of low to medium intensity traffic. The capacity of roundabouts can be significantly increased if they are large in size but space constraints in urban areas like Pune do not allow having large scale roundabouts. Following are the recommendations-

Size and shape – Roundabouts are ideal at intersections having 4 or more arms. Roundabouts are circular in shape but their effectiveness increases if the roundabout is squarish, or oblong in shape. Roundabout becomes more effective when distance between entry and exit to roundabout increases creating more space for merging and de-merging. Roundabouts should not be too small as heavy vehicles like buses, trucks require large turning space.

Roundabouts should have radius of 6 m to 15m in Urban Area. 9m and 12m radius roundabouts are suitable for mix type of traffic. There should be at least 2 lanes (min 6m) at entry and exit of roundabouts.

Access - Roundabouts should be accessible to pedestrians by making approaching arms fan out at a roundabout, thus creating triangular pedestrian refuges on each arm.

Treating Roundabouts – Roundabouts can have landscape, sculptures, public art etc but care should be taken that it does not obstruct the visibility of commuters and does not distract them from driving causing accidents. Roundabouts are ideal spaces for innovative art installations.

Utility Designs for Intersections -

Streets are also the utility carriers. Utilities like Storm water drains, sewerage, water supply lines, electrical, telephone and gas lines are laid underneath the streets. These utilities need frequent up gradation and maintenance. IRC has recently recommended provision of Multiutility zone or dedicated unpaved space on streets for utilities but having a dedicated space for utilities at intersections may not be possible at busy intersections of the city. Digging for utilities is a major cause of disruption of pedestrian and traffic flows especially at intersections. Following are the recommendations-

Providing Cross Ducts –

Intersections on Mobility and Feeder corridors should have properly designed and accessible cross ducts 50m away on all arms of intersections. The change in directions, new connections, new lines and maintenance should be carried out from these cross ducts. Except storm water ducts, other services can be organized from these cross ducts.

Raising level of Intersection-

It is observed many times that intersections become saturation points where rain water from all arms gets collected. Proper storm water drain provision at edge of the street should be done for intersections to avoid water accumulation. For this intersections need to be slightly raised above road level. No drainage chambers, water supply vaults, maintenance shafts etc should be located on intersections. Existing utilities should be shifted to the edge.

Utility Shifting-

Utilities present at intersections should be properly shifted to the sides and cross ducts. It is not recommended to have electrical transformers, gas banks, garbage containers etc at intersections.

Signage-

Except traffic signals, direction signs and street lights intersections should not have advertisements / hoardings which will obstruct the traffic and pedestrian flow or divert the attention of vehicle drivers.

Trees – It is not advisable to have large trees at major intersections. Big trees need to be shifted 50m away from intersections on Mobility corridors. However low height landscape which will not affect the vehicular, pedestrian flow and visibility and underground utilities can be located near the intersections.

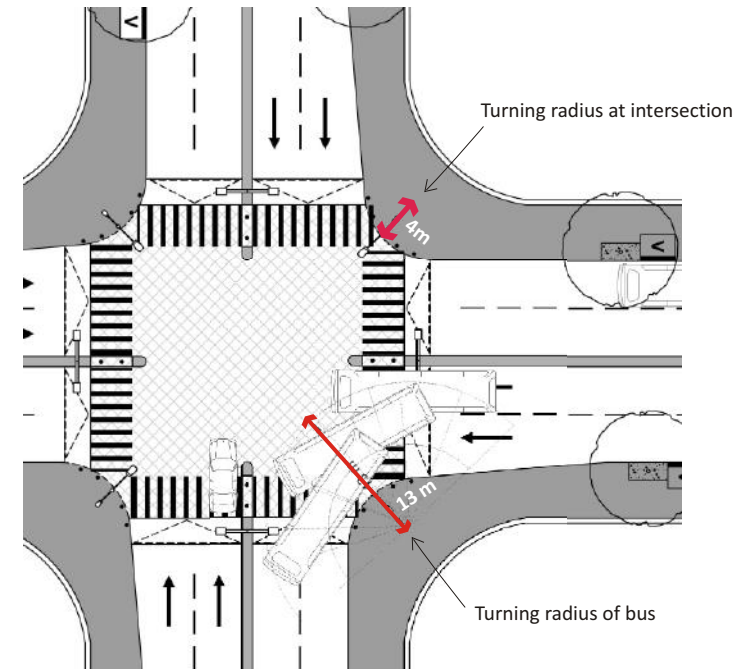

Raised Intersection and Bus turning movement at turn with radius 13 m

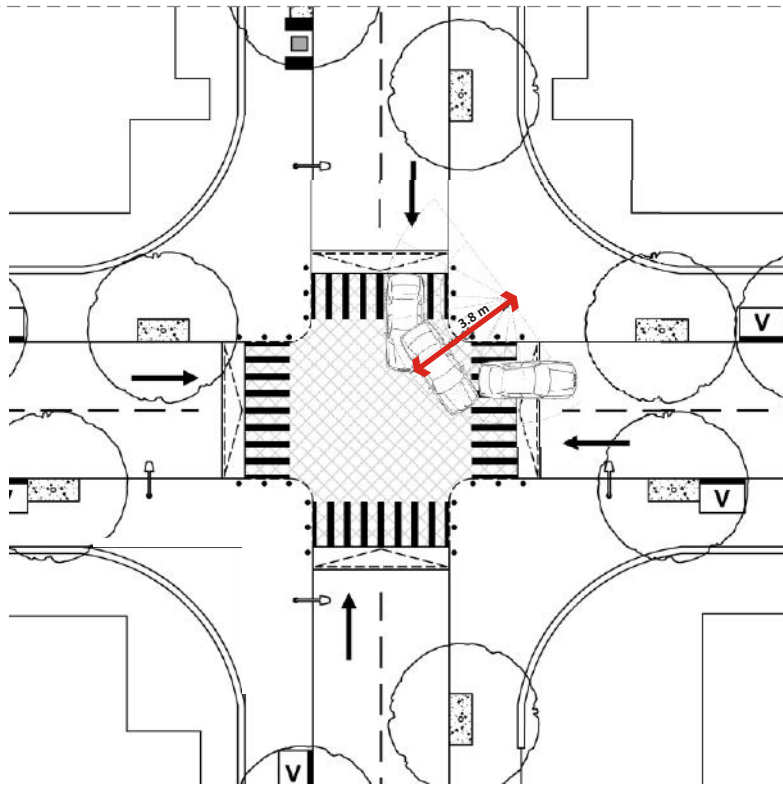

Intersection with tight turns

Since larger turning radii encourage faster vehicle speeds, tighter corners are preferred because they improve safety for pedestrians and cyclists. For local streets that cater to light vehicles, a 4m radius is appropriate. While larger streets need to take into account the turning radius requirements of buses and trucks, it should be noted that the effective turning radius is often much larger than the radius of the built curb.

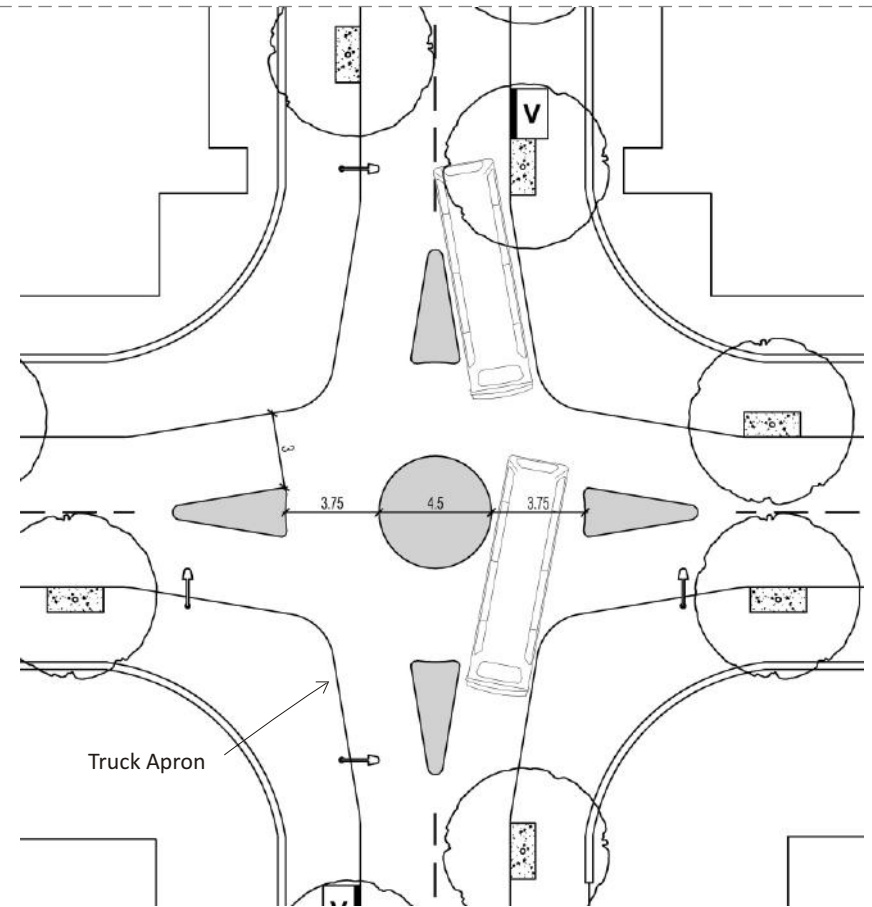

Intersection with Roundabouts

In unsignalised intersections, a roundabout can improve safety by consolidating intersection movements and reducing speeds. Roundabouts also simplify the conflict associated with right turns, which are the major cause of intersection crashes.

In small intersections, the roundabout itself as well as the islands in the centre of the four street arms may be constructed with truck aprons that are surmountable by trucks and buses but not by cars and two wheelers. Such a design accommodates the larger turning radius of heavy vehicles while maintaining a smaller turning radius for other vehicles.

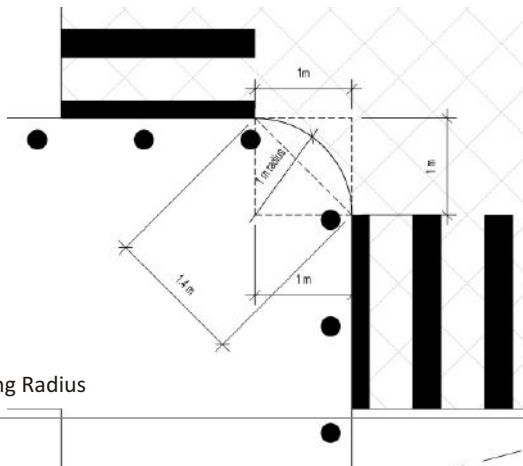

Measuring Turning Radius

While designing streets with varying ROWs or for streets with ROWs that are not given in reference templates, streets should be designed by referring the template of ROW that is smaller than the actual width. Remaining space should be utilized for NMT-Footpath/cycle track/MUZ.

For eg: For streets with ROW 20 meters, street template for ROW 18 meters should be used and remaining 2 meters should be designed as a part of NMT space.

USDG REFERENCE TEMPLATES

Provides for standard drawing templates for street cross sections of various widths and also for intersections based on USDG principles and recommendations for street designing

08

6A

6 MTS. RIGHT OF WAY- A

Recommended for by-lanes, narrow lanes, alleys in a residential neighbourhood

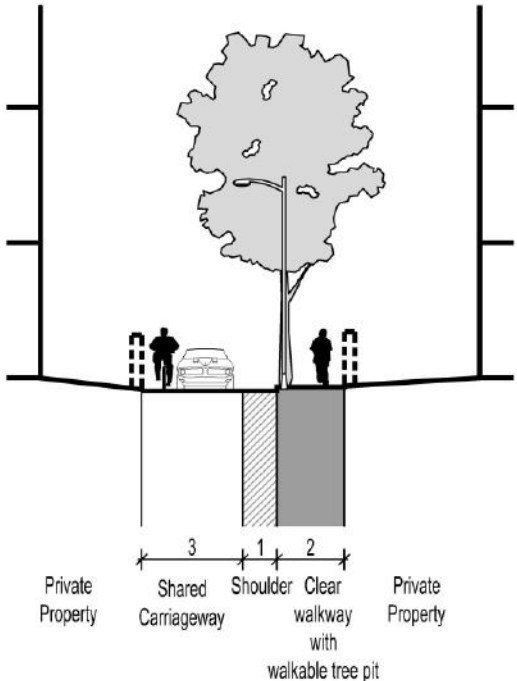

Elements of Street	Type/Composition	Surrounding Land use/Activity
Footpath	One Side	Residential Neighbourhood
Cycle Track	---	Mixed Use
Carriageway	Two way, Undivided	Institutional
Parallel Parking	---	Special Streets
Street Vending	Low Demand	Through Traffic

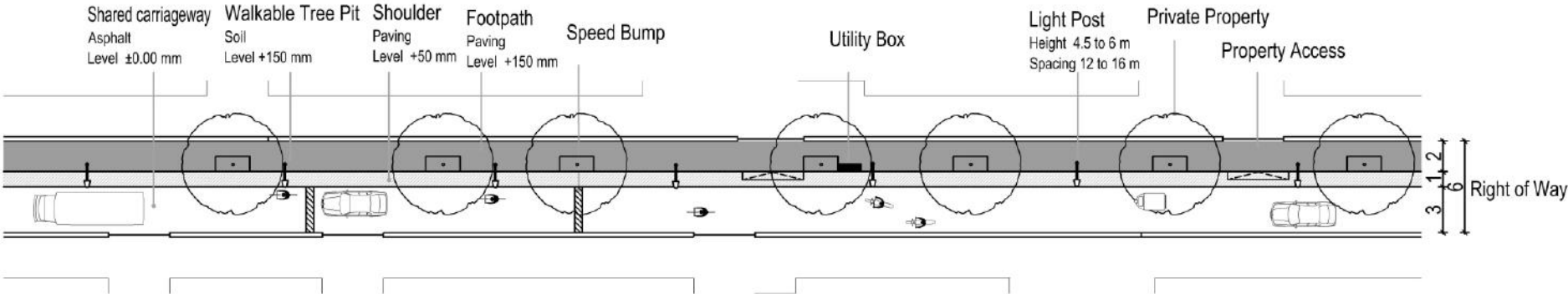

6B

6 MTS. RIGHT OF WAY- B

Recommended for one way by-lanes, narrow lanes, alleys in a residential neighbourhood with traffic calming measures

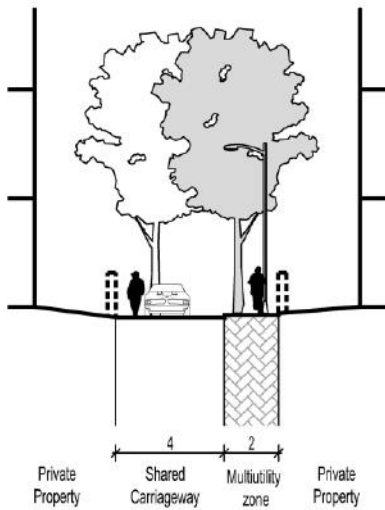

Section at MUZ for pedestrian activities

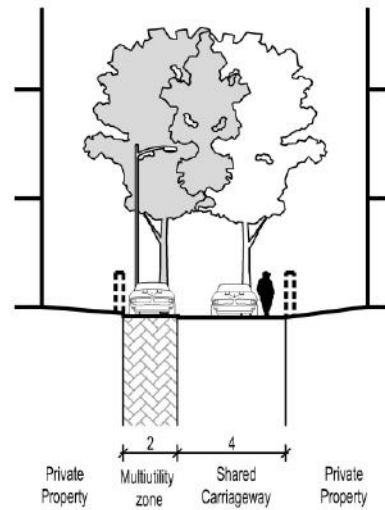

Section at MUZ for parking

Elements of Street	Type/Composition	Surrounding Land use/Activity
Footpath	---	Residential Neighbourhood
Cycle Track	---	Mixed Use
Carriageway	Two way, Undivided	Institutional
Parallel Parking	Yes	Special Streets
Street Vending	Low Demand	Through Traffic

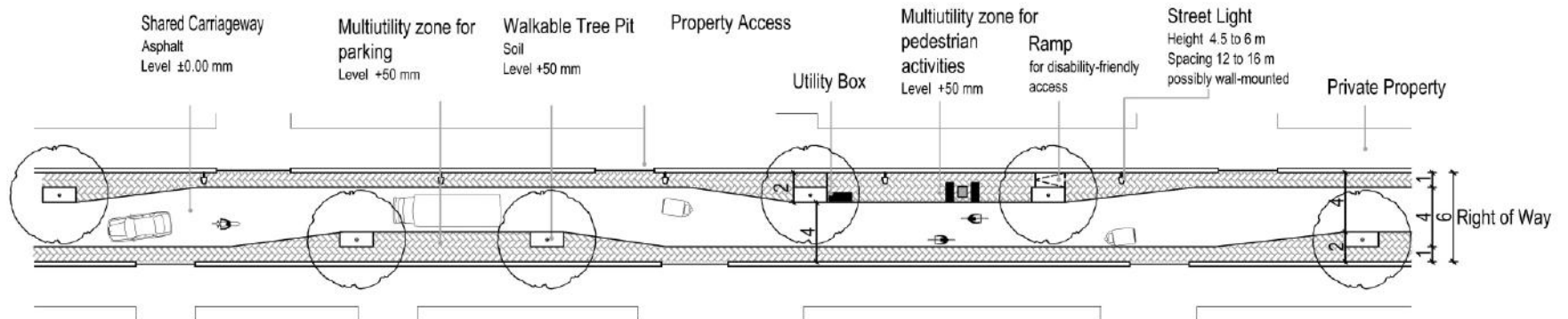

7.5A

7.5 MTS. RIGHT OF WAY-A

Recommended for by-lanes, narrow lanes, alleys in a residential neighbourhood with no parking

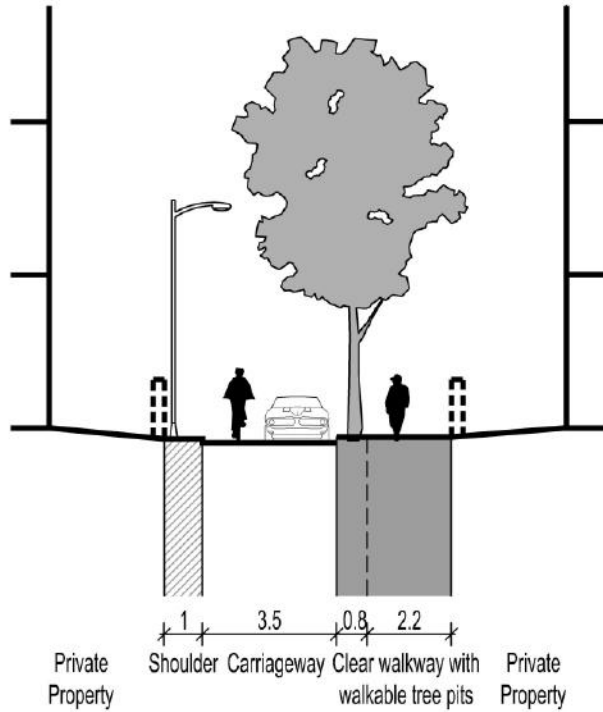

Elements of Street	Type/Composition	Surrounding Land use/Activity
Footpath	One Side	Residential Neighbourhood
Cycle Track	---	Mixed Use
Carriageway	Two Way, Undivided	Institutional
Parallel Parking	---	Special Streets
Street Vending	Low Demand	Through Traffic

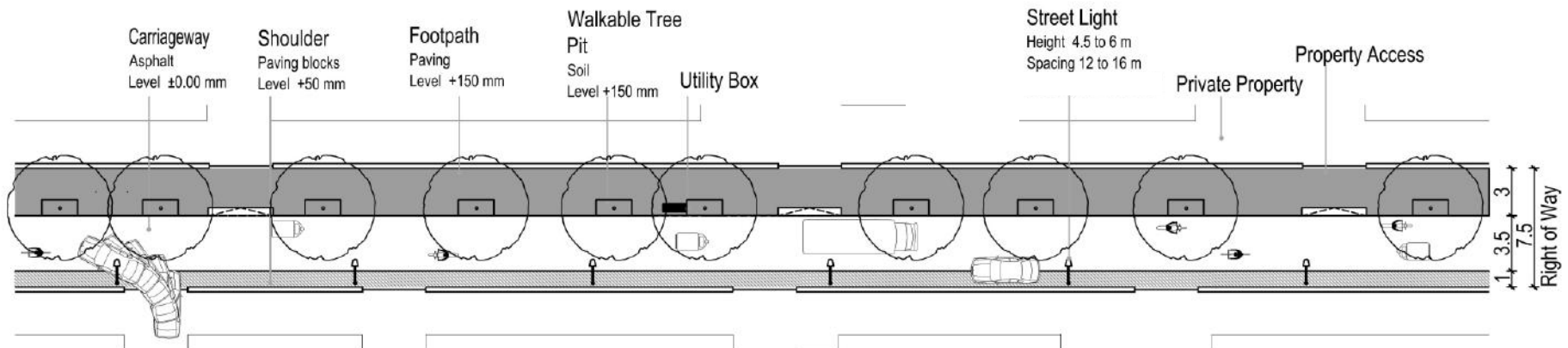

7.5B

7.5 MTS. RIGHT OF WAY-B

Recommended for by-lanes, narrow lanes, alleys in a residential neighbourhood with parking requirements and traffic calming measures such as speed bumps

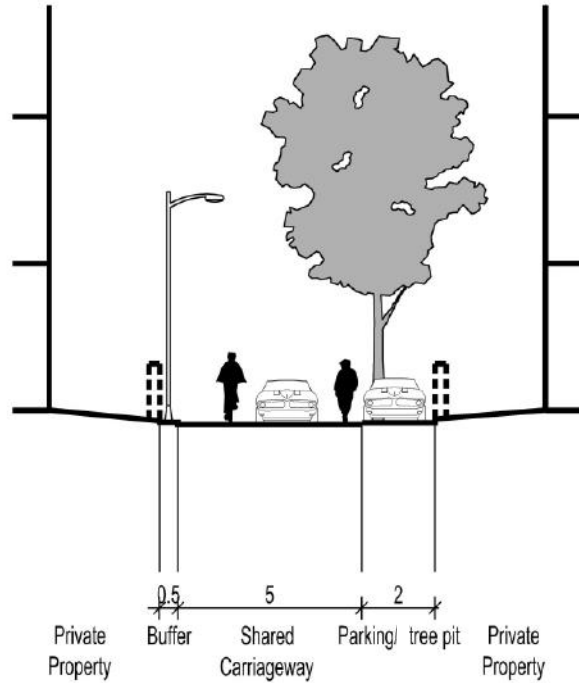

Elements of Street	Type/Composition	Surrounding Land use/Activity
Footpath	---	Residential Neighbourhood
Cycle Track	---	Mixed Use
Carriageway	Two Way, Undivided	Institutional
Parallel Parking	Yes	Special Streets
Street Vending	Low Demand	Through Traffic

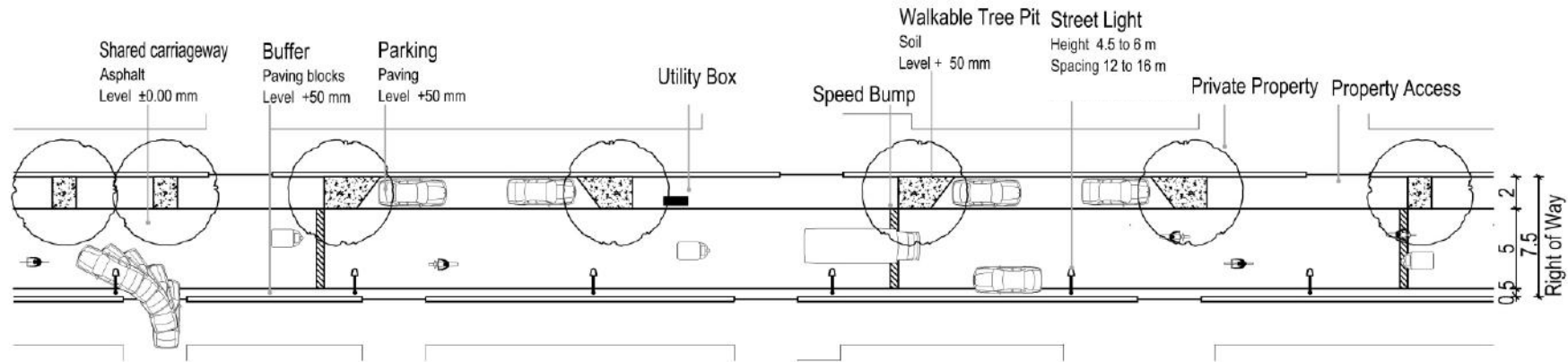

9A

9 MTS. RIGHT OF WAY-A

Recommended for narrow streets in residential areas in Peths and Gaothan

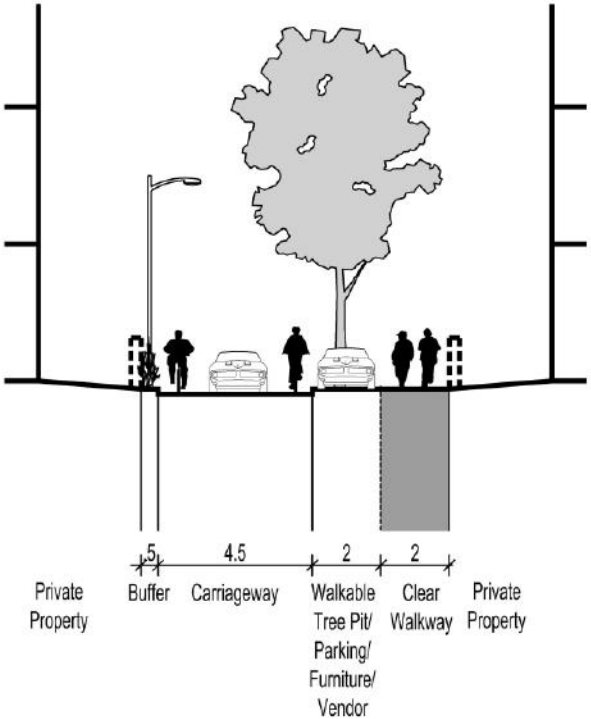

Elements of Street	Type/Composition	Surrounding Land use/Activity
Footpath	One Side	Residential Neighbourhood
Cycle Track	---	Mixed Use
Carriageway	Two Way, Undivided	Institutional
Parallel Parking	Yes	Special Streets
Street Vending	Medium Demand	Through Traffic

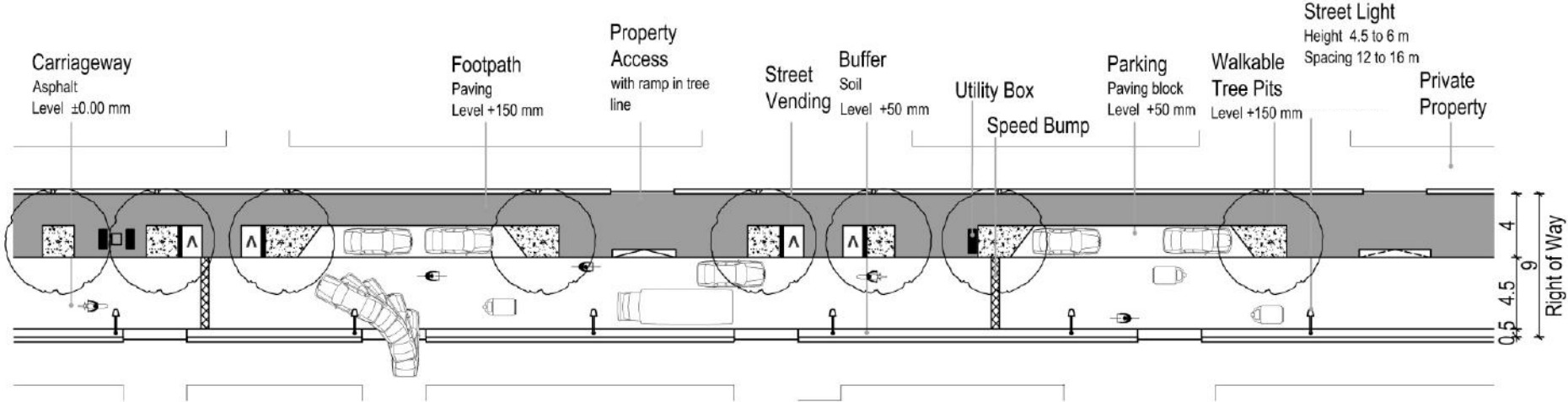

9B

9 MTS. RIGHT OF WAY-B

Recommended for narrow streets in commercial areas with higher pedestrian footfall such as streets in Kasba Peth, Rasta Peth, Mangalwar Peth, Bhavani Peth etc.

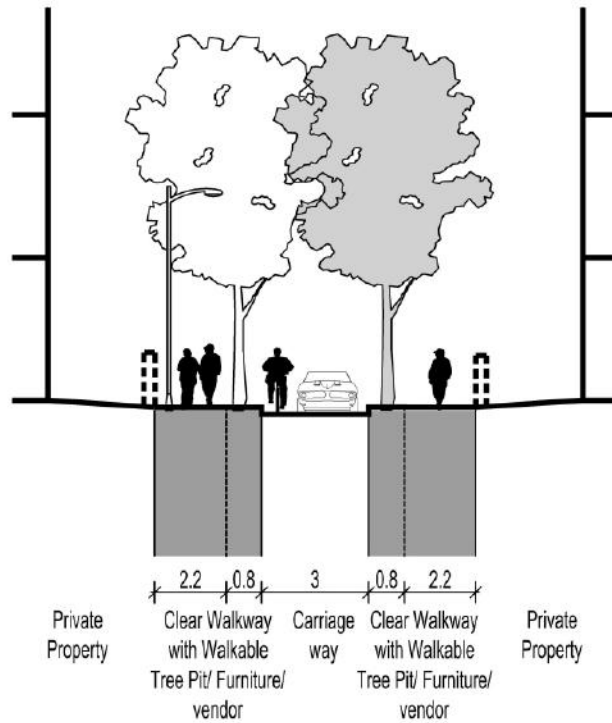

Elements of Street	Type/Composition	Surrounding Land use/Activity
Footpath	Both Sides	Residential Neighbourhood
Cycle Track	---	Mixed/commercial (High Pedestrian footfall)
Carriageway	One Way, Undivided	Institutional
Parallel Parking	---	Special Streets
Street Vending	High Demand	Through Traffic

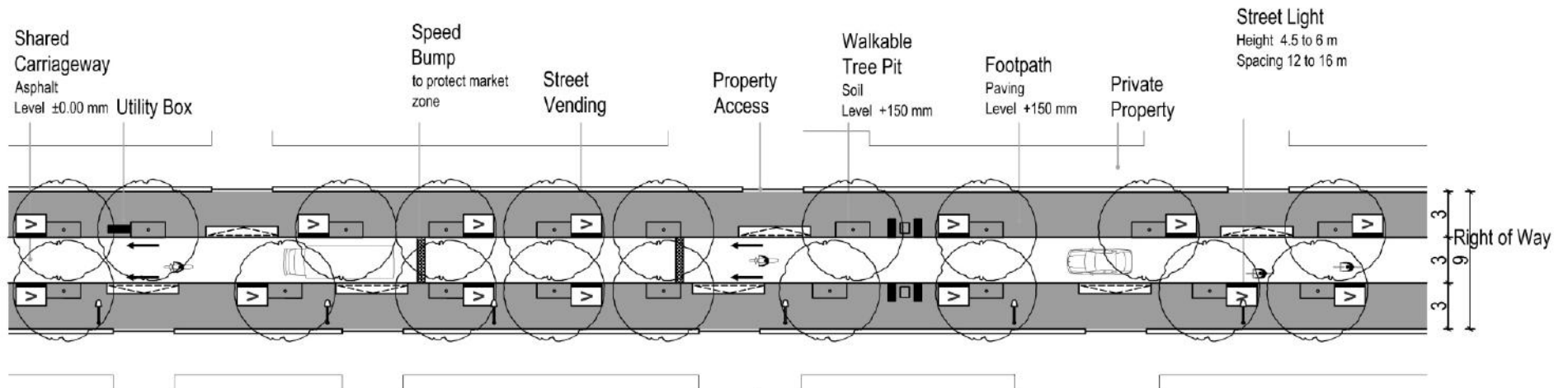

12A

12 MTS. RIGHT OF WAY-A

Recommended for through traffic in a residential or mixed landuse area

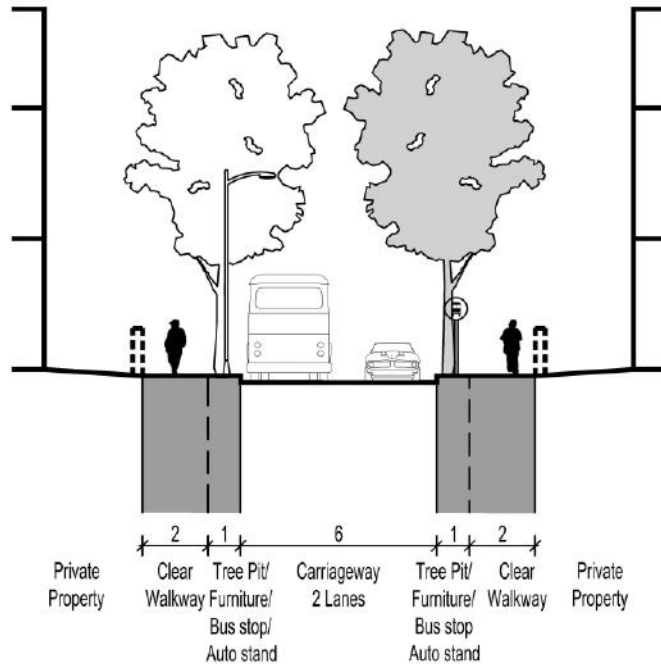

Section at the Bus stop

Elements of Street	Type/Composition
Footpath	Both Sides
Cycle Track	---
Carriageway	Two Way, Undivided
Parallel Parking	---
Street Vending	Low Demand

Surrounding Land use/Activity
Residential Neighbourhood
Mixed Use
Institutional
Special Streets
Through Traffic

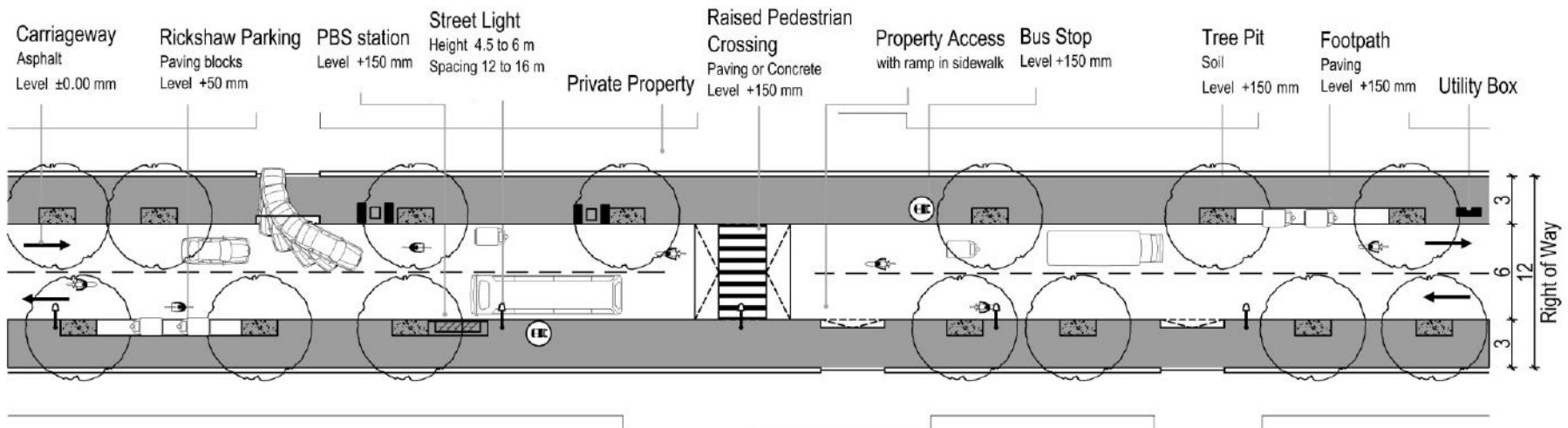

12B

12 MTS. RIGHT OF WAY-B

Recommended for by-lanes in a residential or mixed use area with traffic calming measures such as chicane/meandering carriageway

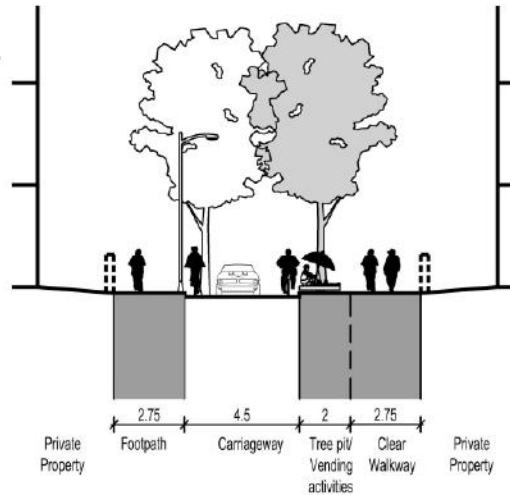
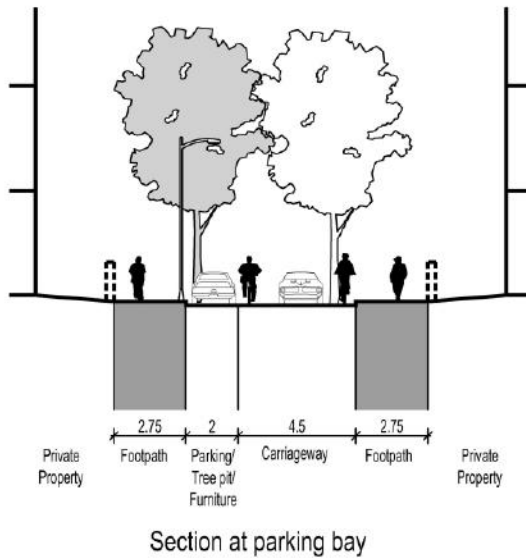

Elements of Street	Type/Composition	Surrounding Land use/Activity
Footpath	Both Sides	Residential Neighbourhood
Cycle Track	---	Mixed Use
Carriageway	Two Way, Undivided	Institutional
Parallel Parking	Yes	Special Streets
Street Vending	Medium Demand	Through Traffic

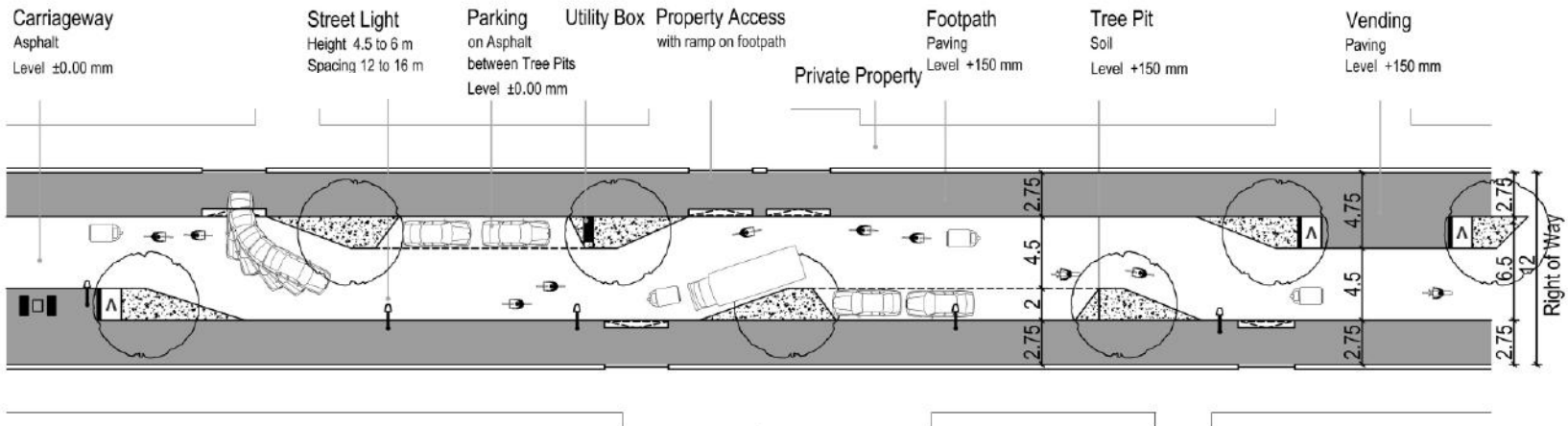

12C

12 MTS. RIGHT OF WAY-C

Recommended for through traffic with traffic calming features for by-lanes in a residential neighbourhood

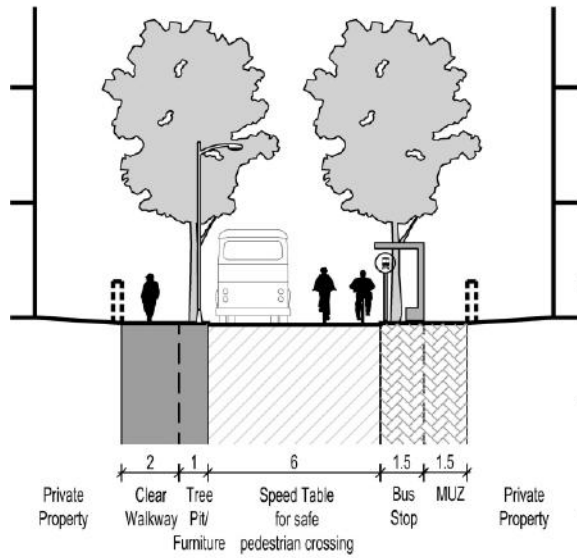

Section at speed table

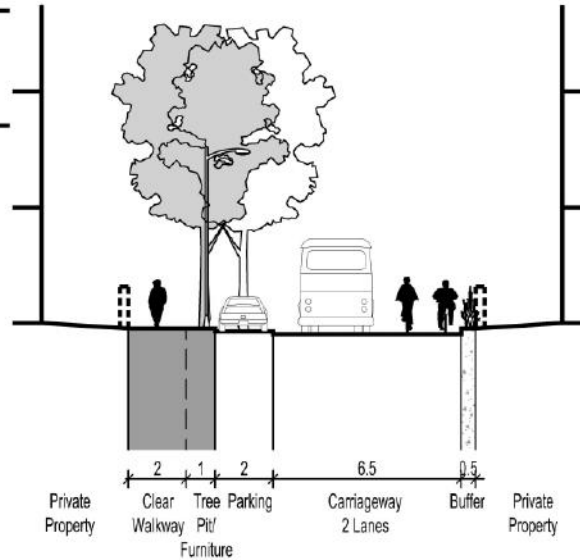

Section at parking bay

Elements of Street	Type/Composition	Surrounding Land use/Activity
Footpath	Both Sides	Residential Neighbourhood
Cycle Track	---	Commercial
Carriageway	Two Way, Undivided	Institutional
Parallel Parking	Yes	Special Streets
Street Vending	Low Demand	Through Traffic (Traffic Calming)

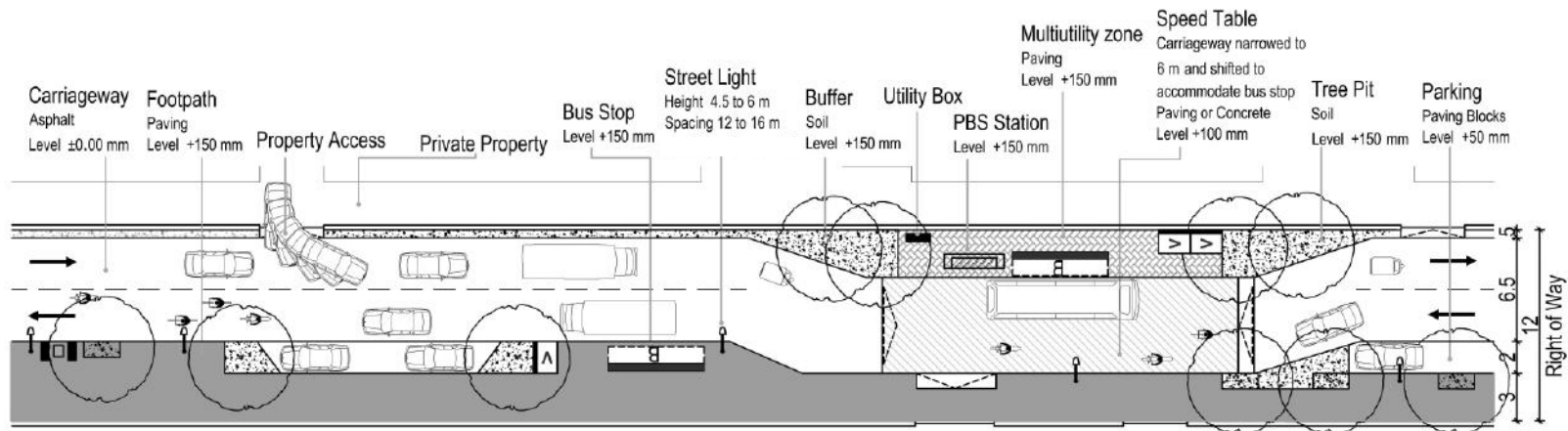

12D

12 MTS. RIGHT OF WAY-D

Recommended for streets in commercial areas with high pedestrian footfall such as streets in Peths and Gaothan areas with P1-P2 parking schemes

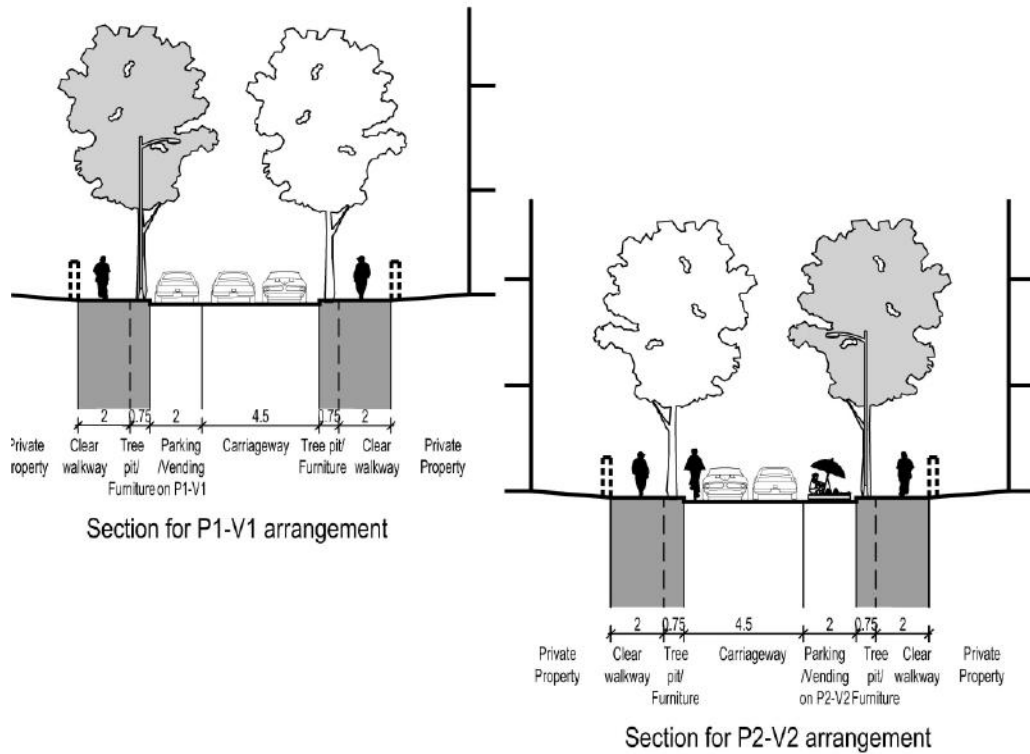

Elements of Street	Type/Composition	Surrounding Land use/Activity
Footpath	Both Sides	Residential Neighbourhood
Cycle Track	---	Mixed/Commercial (High Pedestrian footfall)
Carriageway	Two Way, Undivided	Institutional
Parallel Parking	P1-P2 basis	Special Streets
Street Vending	High Demand, V1-V2 Basis	Through Traffic

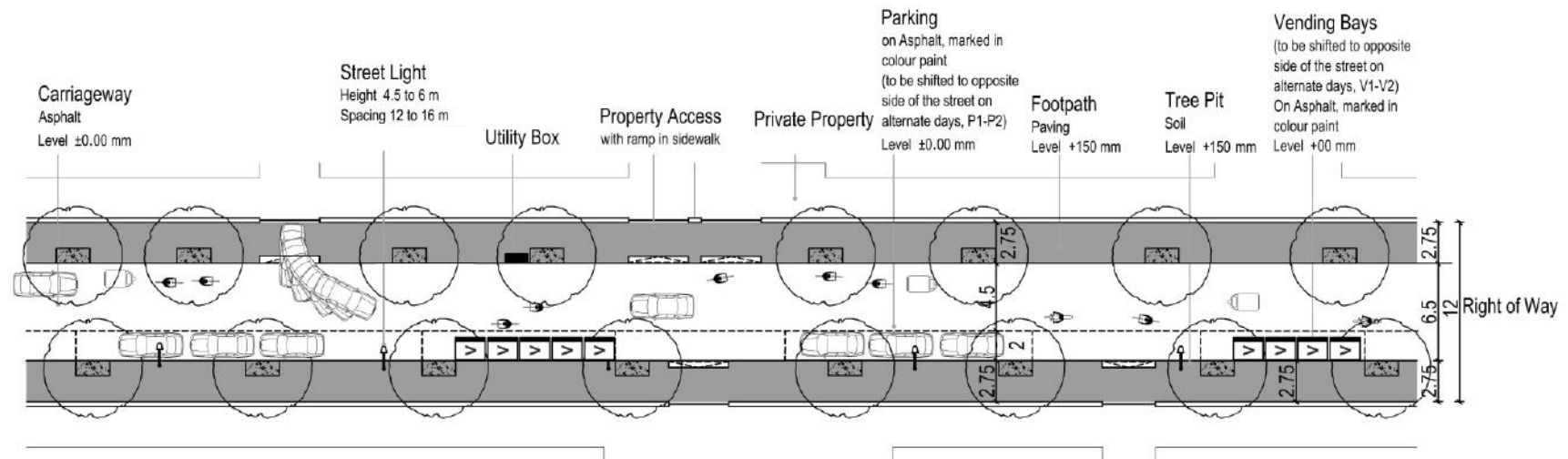

12E

12 MTS. RIGHT OF WAY-E

Recommended for streets strictly for two wheelers only.

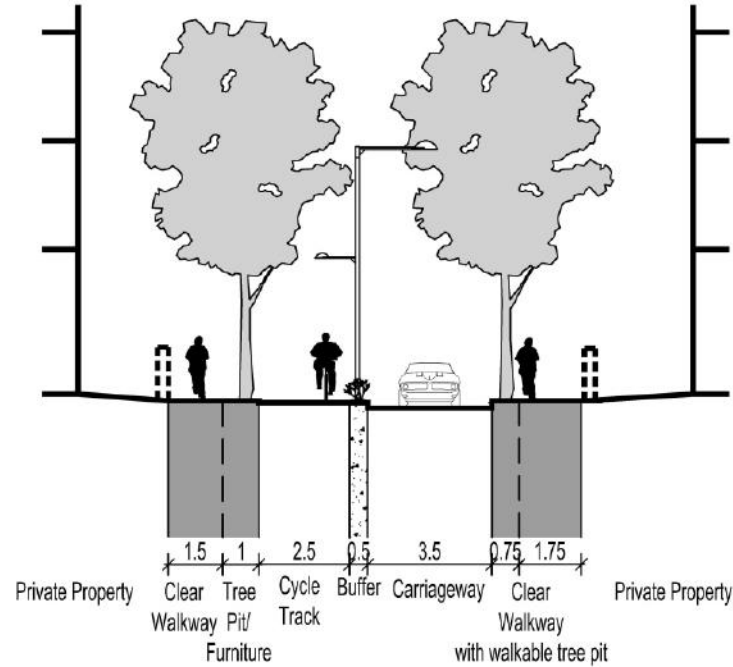

Elements of Street	Type/Composition	Surrounding Land use/Activity
Footpath	Both Sides	Residential Neighbourhood
Cycle Track	One side	Mixed Use
Carriageway	Two Way, Undivided	Institutional
Parallel Parking	---	Special Streets (Two Wheeler-only)
Street Vending	Low Demand	Through Traffic

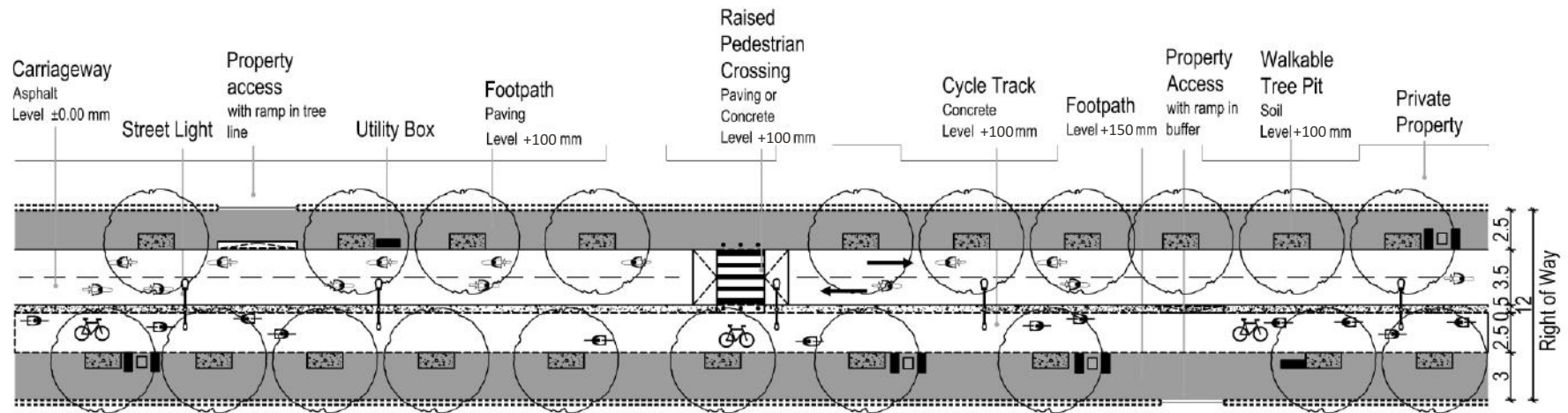

15A

15 MTS. RIGHT OF WAY-A

Recommended for streets alongside educational institutes, schools, colleges.

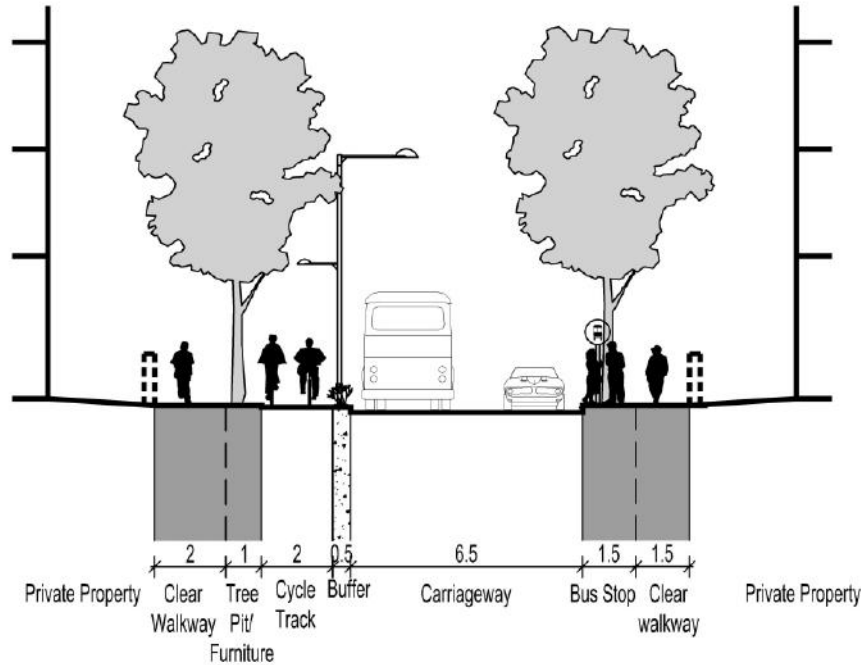

Elements of Street	Type/Composition	Surrounding Land use/Activity
Footpath	Both Side	Residential Neighbourhood
Cycle Track	One Side	Mixed Use
Carriageway	Two Way, Undivided	Institutional
Parallel Parking	---	Special Streets
Street Vending	Medium Demand	Through Traffic

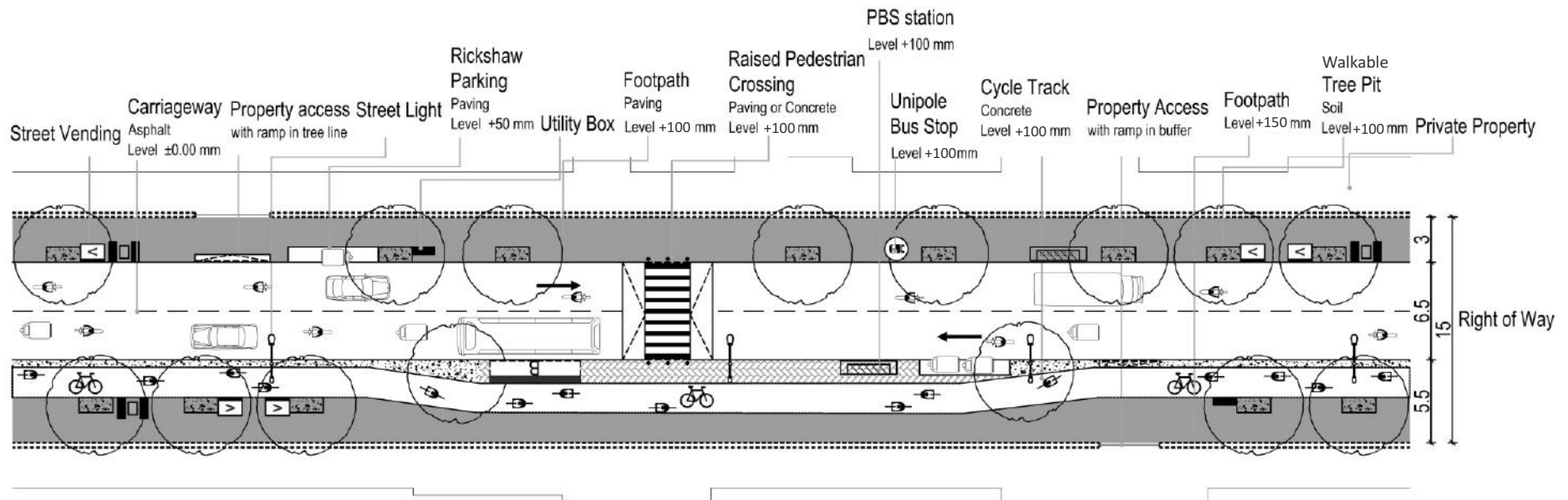

15B

15 MTS. RIGHT OF WAY-B

Recommended for streets with through traffic in a residential or mixed use area

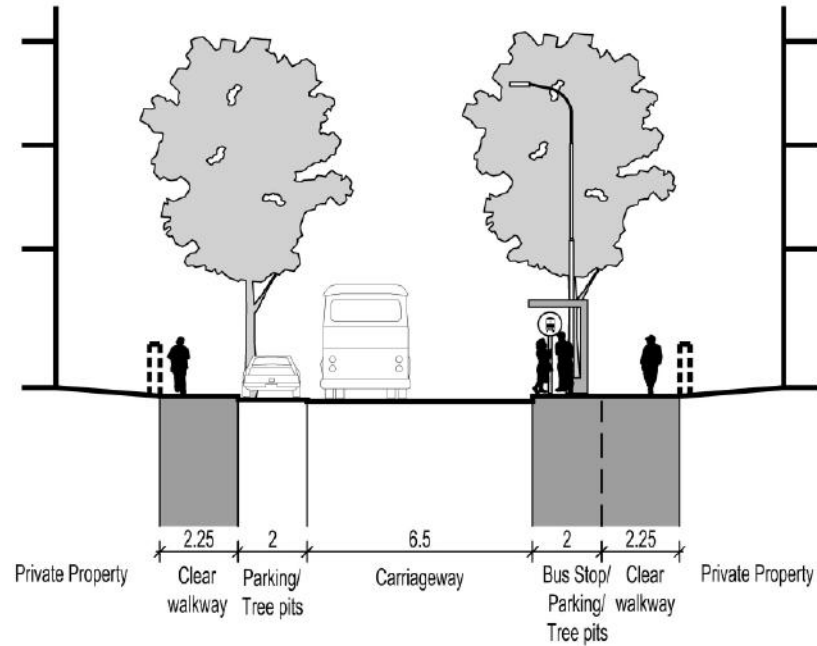

Elements of Street	Type/Composition
Footpath	Both Side
Cycle Track	---
Carriageway	Two Way, Undivided
Parallel Parking	Yes
Street Vending	Medium Demand

Surrounding Land use/Activity
Residential Neighbourhood
Mixed Use
Institutional
Special Streets
Through Traffic

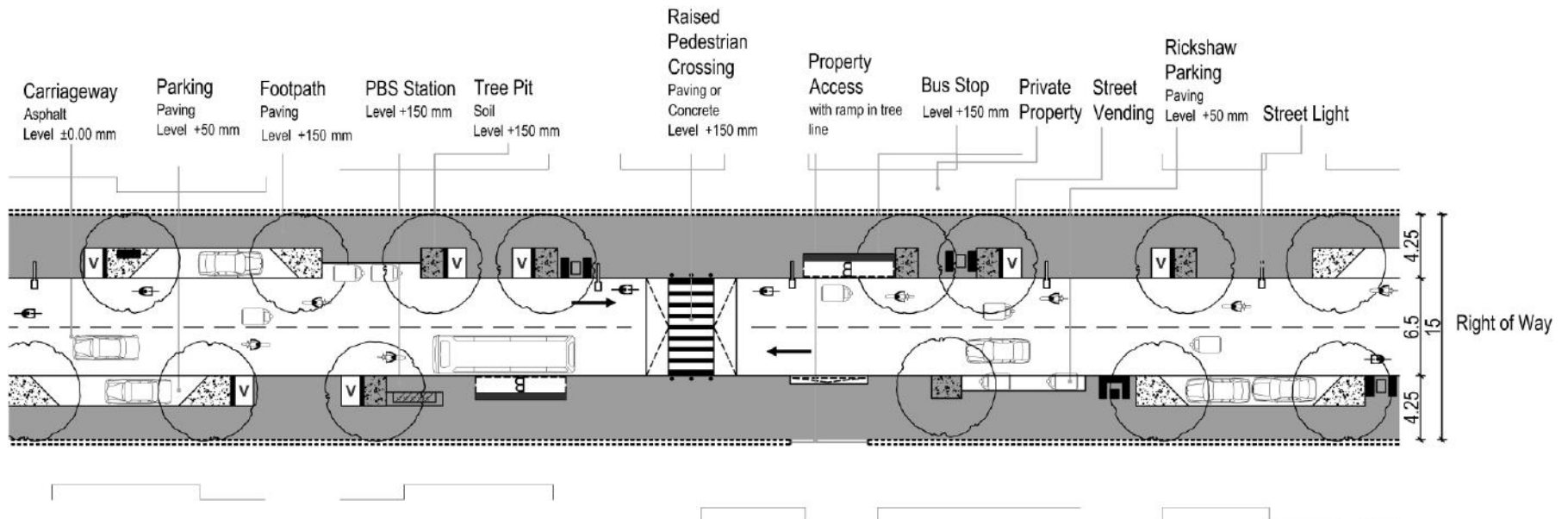

15C

15 MTS. RIGHT OF WAY-C

Recommended for one way streets with high pedestrian footfall and vendors in busy commercial or mixed use areas, such as Bajirao road, Shivaji Road etc.

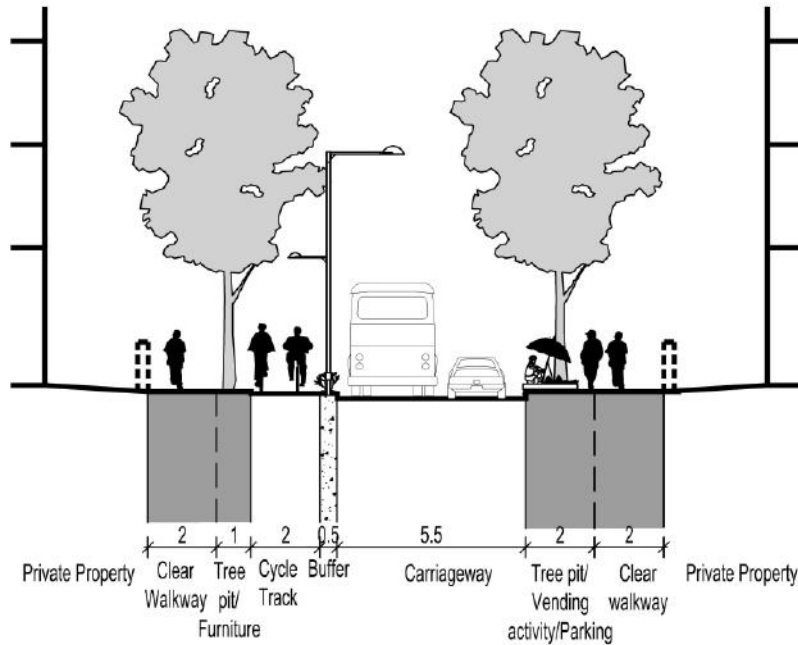

Elements of Street	Type/Composition	Surrounding Land use/Activity
Footpath	Both Side	Residential Neighbourhood
Cycle Track	One Side	Mixed/ Commercial (High Pedestrian Footfall)
Carriageway	One Way, Undivided	Institutional
Parallel Parking	---	Special Streets
Street Vending	High Demand	Through Traffic

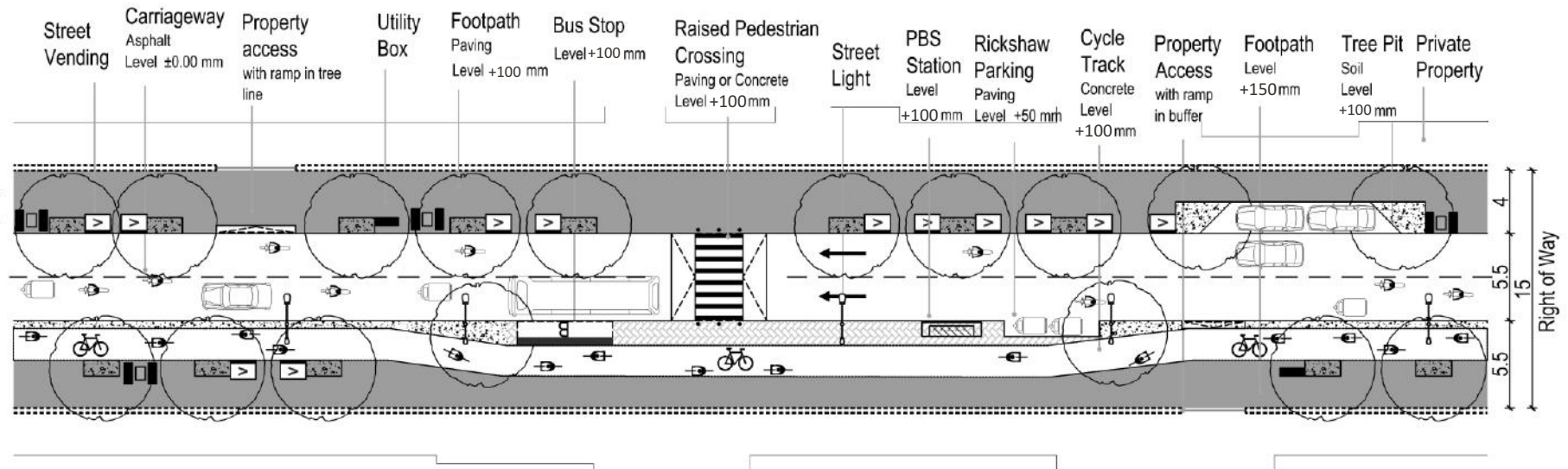

15D

15 MTS. RIGHT OF WAY- D

Recommended for streets that are only NMT friendly with wide public avenues and no private vehicles allowed, such as riverside streets.

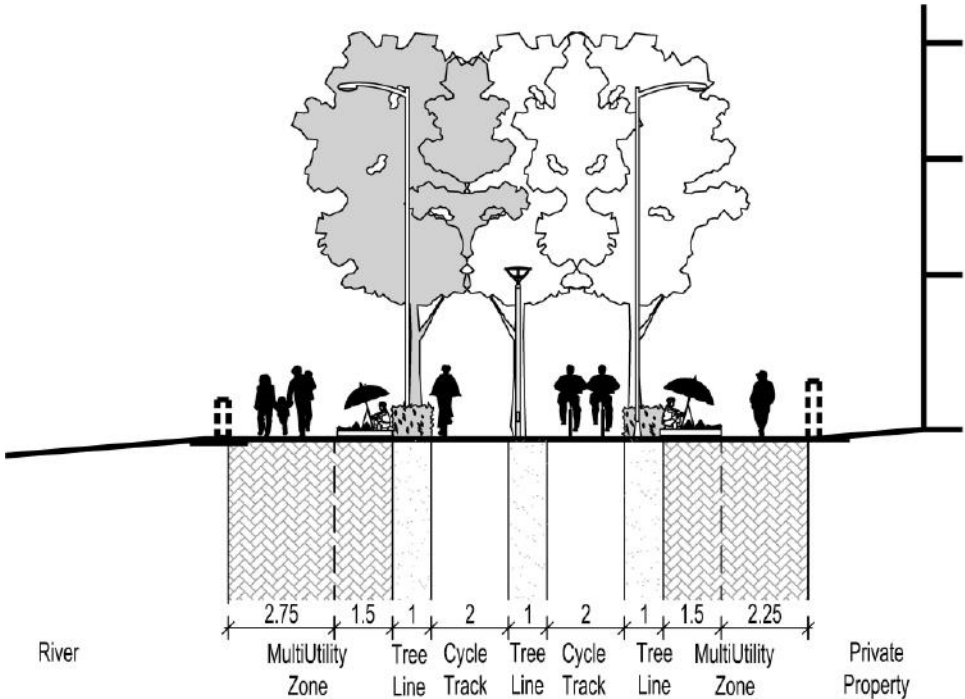

Elements of Street	Type/Composition	Surrounding Land use/Activity
Footpath	Both Sides	Residential Neighbourhood
Cycle Track	Median	MixedUse
Carriageway	---	Institutional
Parallel Parking	---	Special Streets (NMT-only street ,Excellent Livability)
Street Vending	High Demand	Through Traffic

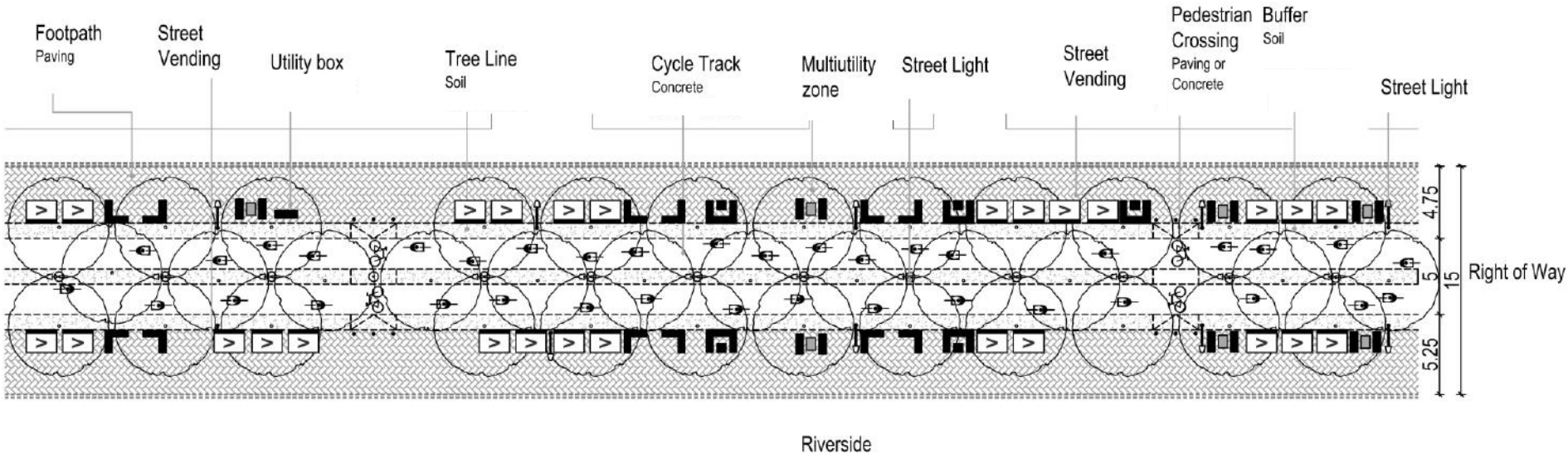

18A

18 MTS. RIGHT OF WAY-A

Recommended for streets alongside educational institutes, schools, colleges and with through traffic

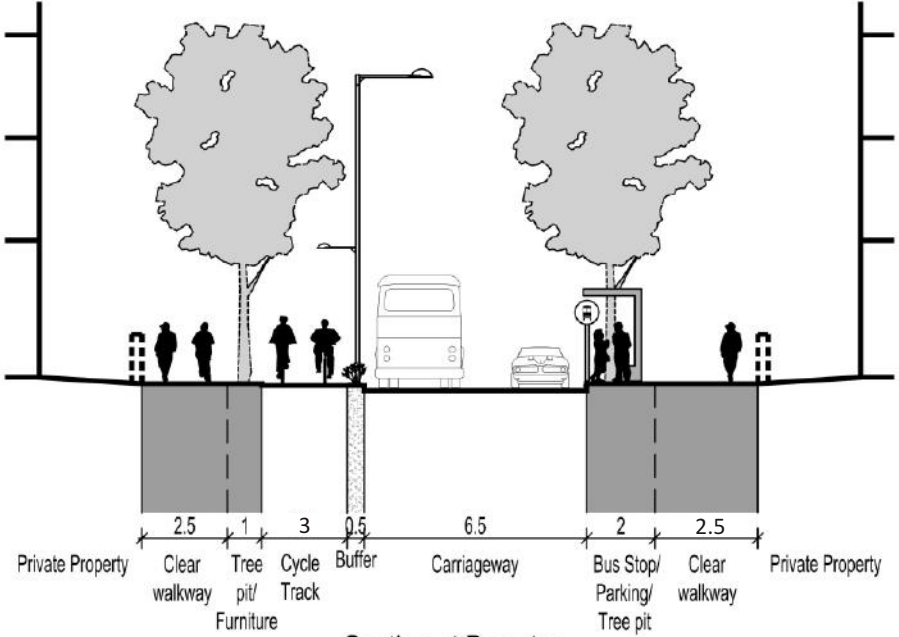

Section at Bus stop

Elements of Street	Type/Composition	Surrounding Land use/Activity
Footpath	Both Side	Residential Neighbourhood
Cycle Track	One Side	Commercial / Mixed use
Carriageway	Two Way, Undivided	Institutional
Parallel Parking	Yes	Special Streets
Street Vending	Low Demand	Through Traffic

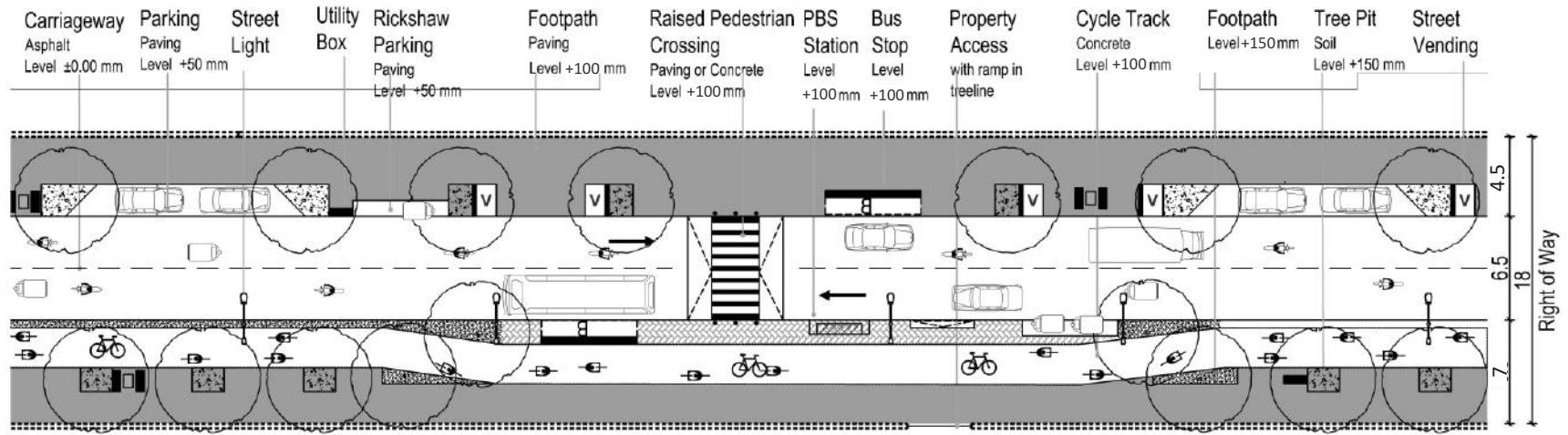

18B

18 MTS. RIGHT OF WAY-B

Recommended for streets alongside educational institutes, schools, colleges

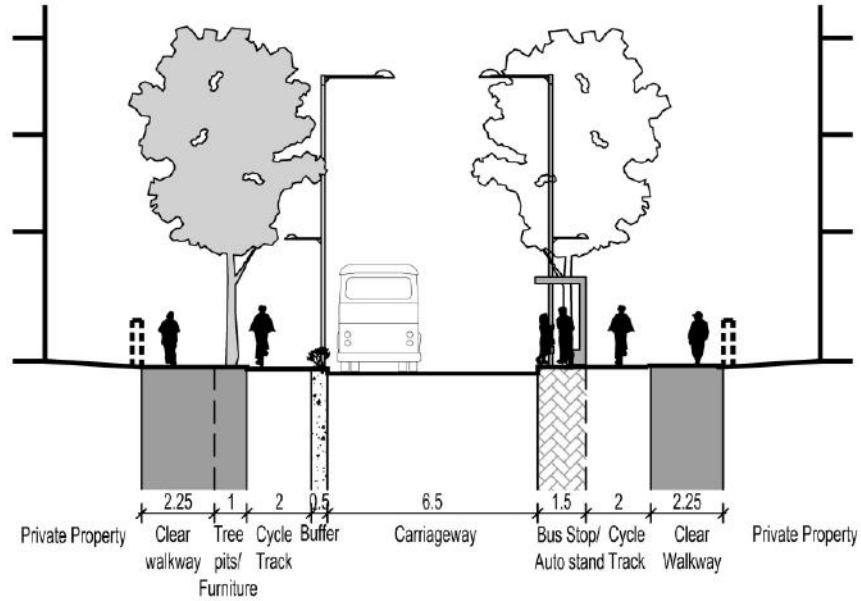

Section at Bus stop

Elements of Street	Type/Composition	Surrounding Land use/Activity
Footpath	Both Side	Residential Neighbourhood
Cycle Track	Both Side	Commercial
Carriageway	Two Way, Undivided	Institutional
Parallel Parking	---	Special Streets
Street Vending	Medium Demand	Through Traffic

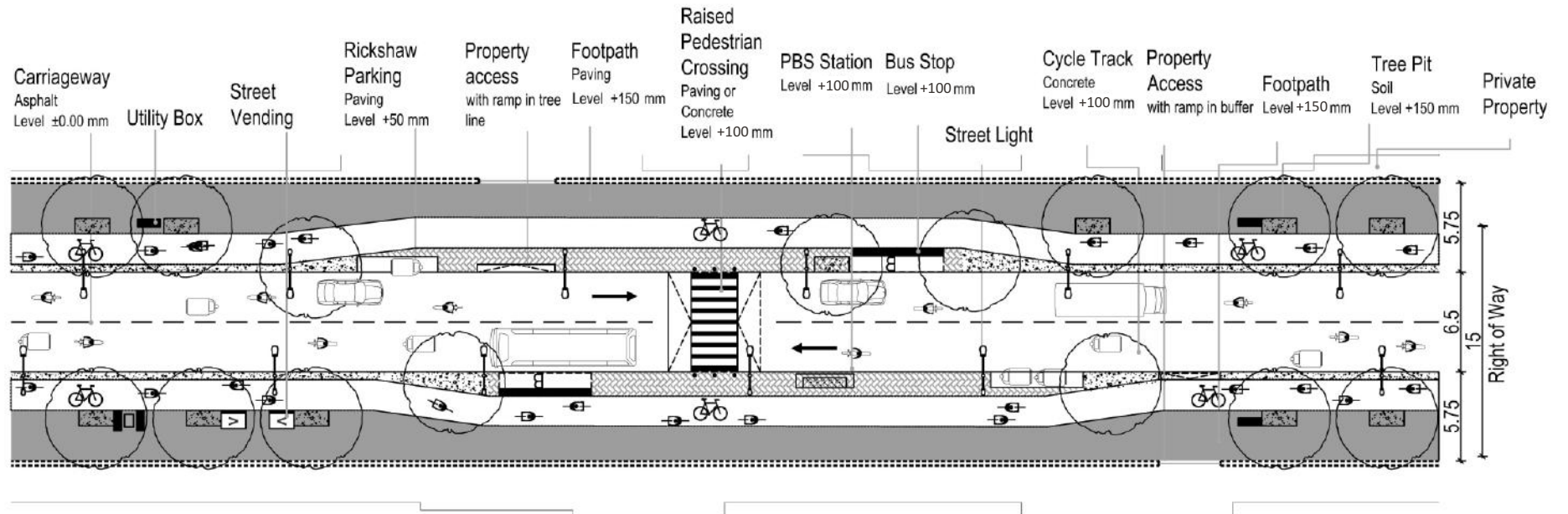

18C

18 MTS. RIGHT OF WAY-C

Recommended for streets with through traffic and parking requirements

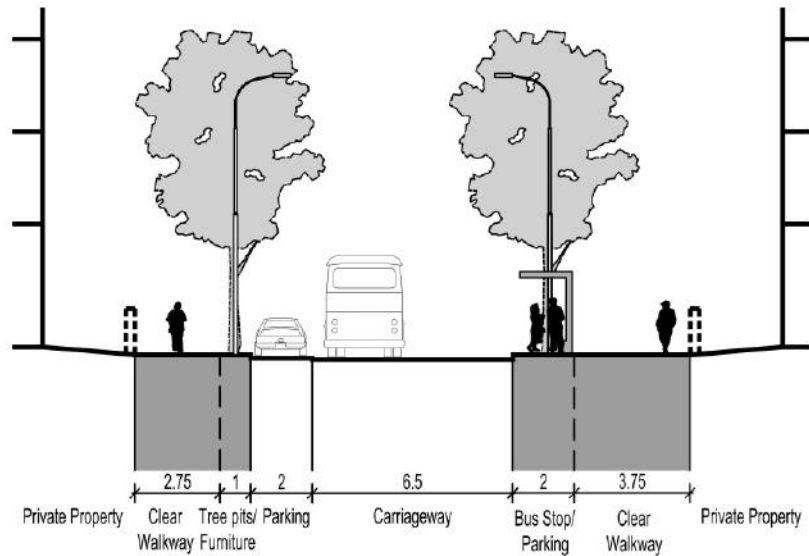

Elements of Street	Type/Composition
Footpath	Both Sides
Cycle Track	---
Carriageway	Two Way, Undivided
Parallel Parking	Yes
Street Vending	Low Demand

Surrounding Land use/Activity
Residential Neighbourhood
Commercial
Institutional
Special Streets
Through Traffic

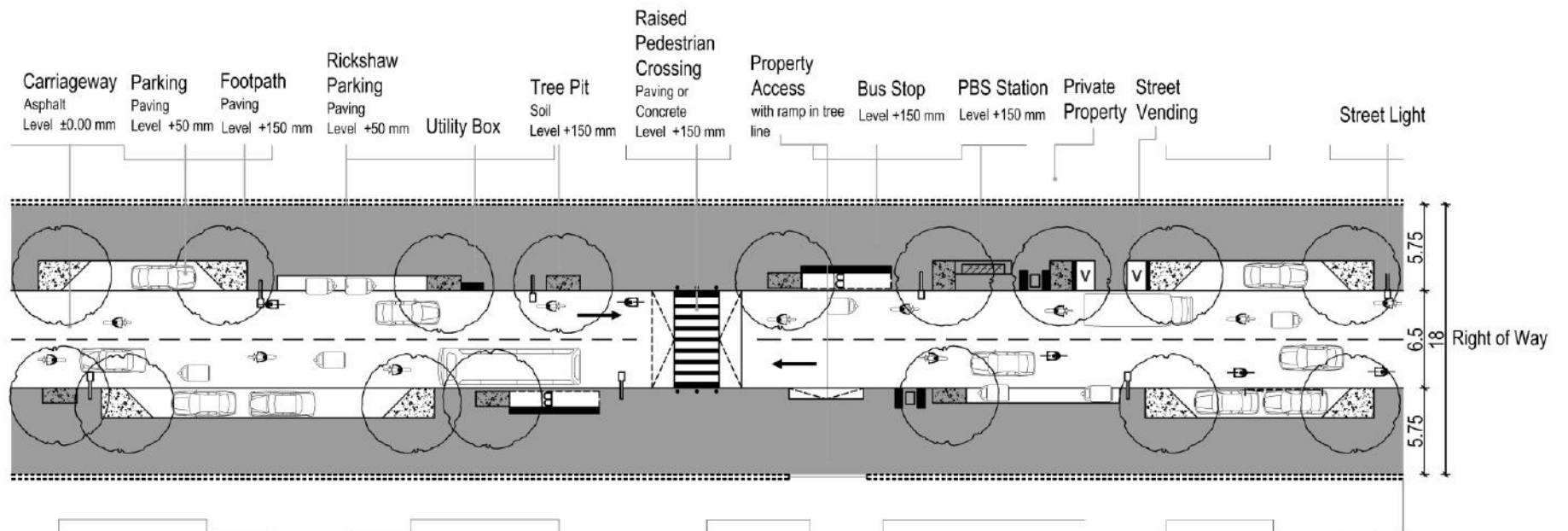

18D

18 MTS. RIGHT OF WAY- D

Recommended for streets with through traffic and no parking zones

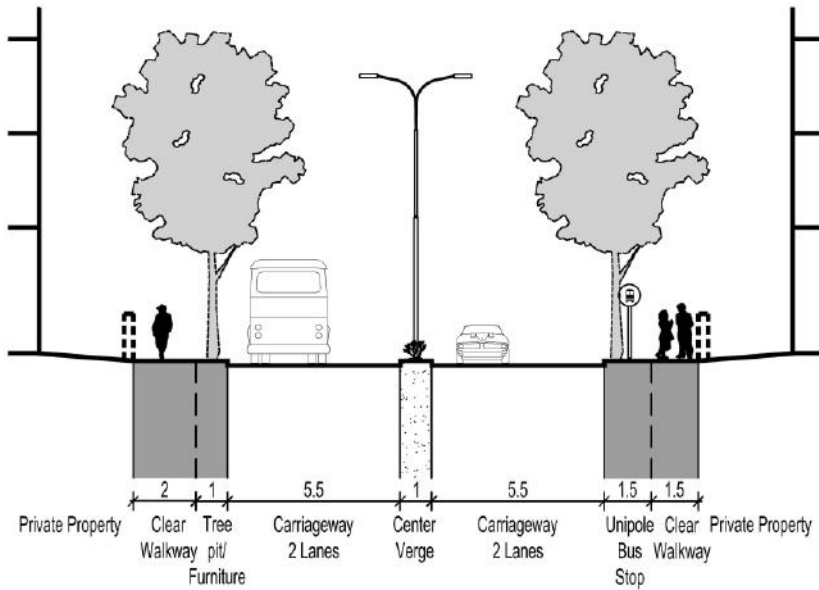

Elements of Street	Type/Composition	Surrounding Land use/Activity
Footpath	Both Sides	Residential Neighbourhood
Cycle Track	---	Commercial
Carriageway	Two Way, Divided	Institutional
Parallel Parking	---	Special Streets
Street Vending	Low Demand	Through Traffic

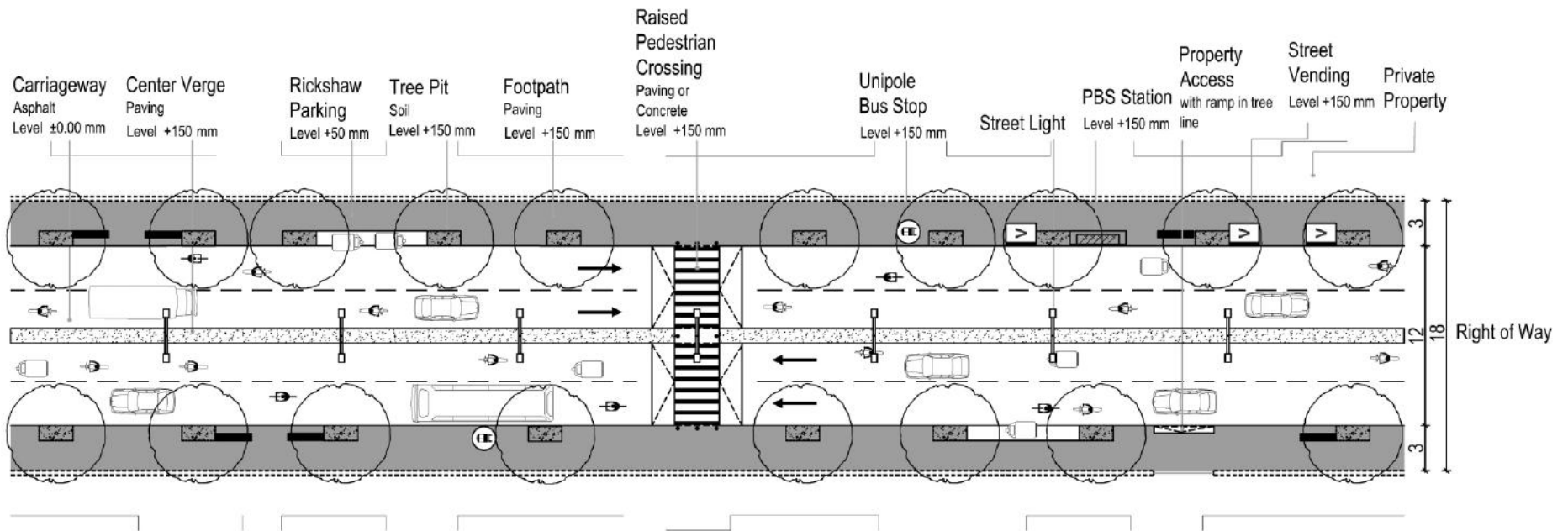

18 BRT

18 MTS. RIGHT OF WAY- BRT

Recommended for narrow one way mobility corridors with through traffic

Elements of Street	Type/Composition	Surrounding Land use/Activity
Footpath	Both Side	Residential Neighbourhood
Cycle Track	---	Commercial /Mixed Use
Carriageway	One Way, Central BRT lane	Institutional
Parallel Parking	---	Special Streets
Street Vending	High Demand	Through Traffic (Mobility Corridor)

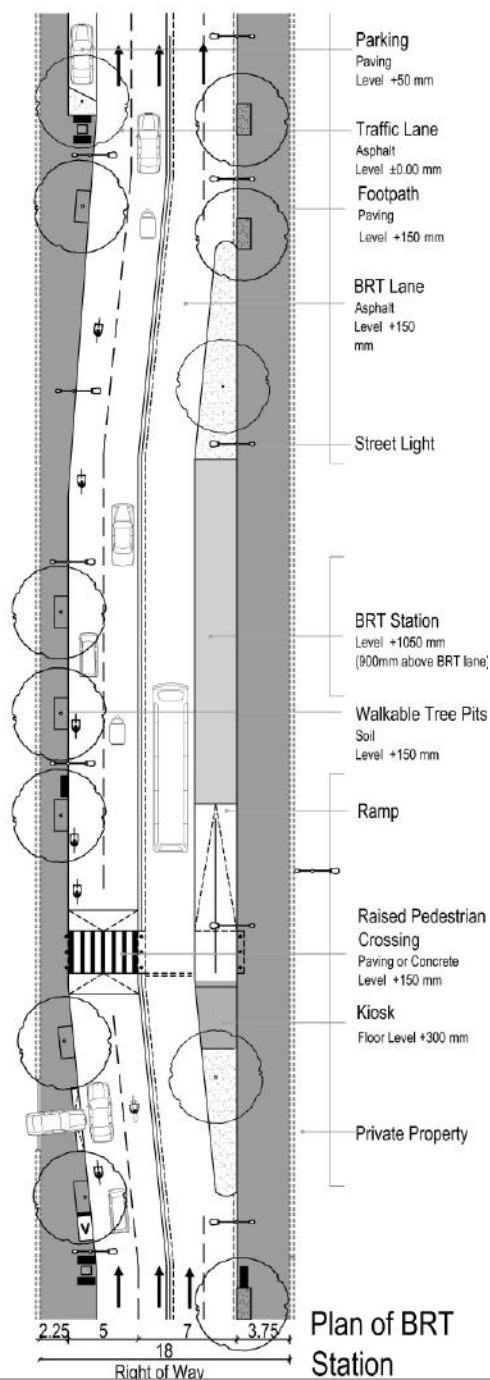
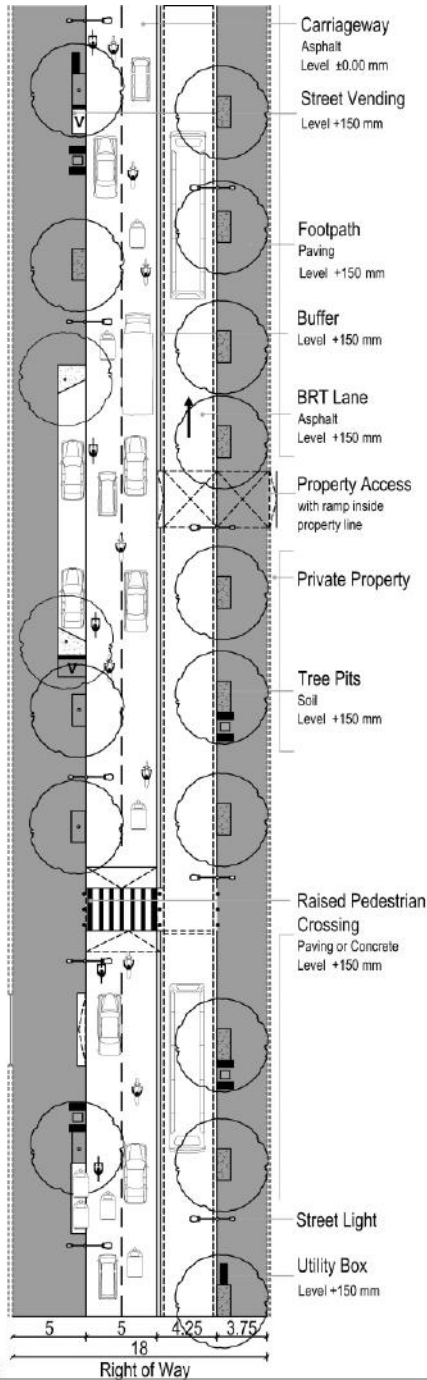
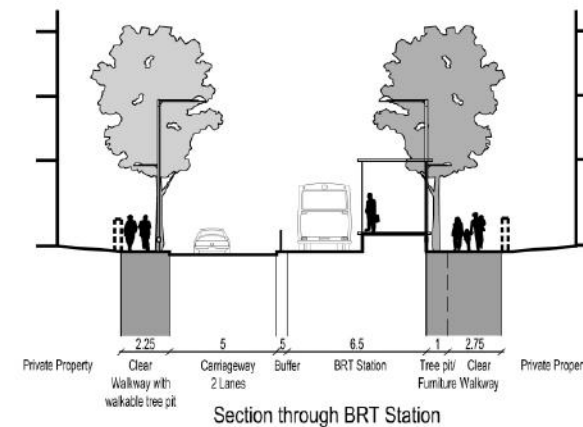
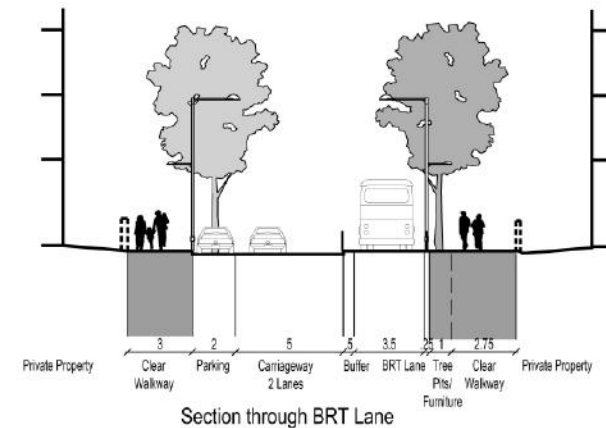

Plan of BRT Lane

Plan of BRT Station

21A

21 MTS. RIGHT OF WAY-A

Recommended for streets in institutional, mixed use or commercial area with heavy pedestrian footfall and street vending activities and with through traffic

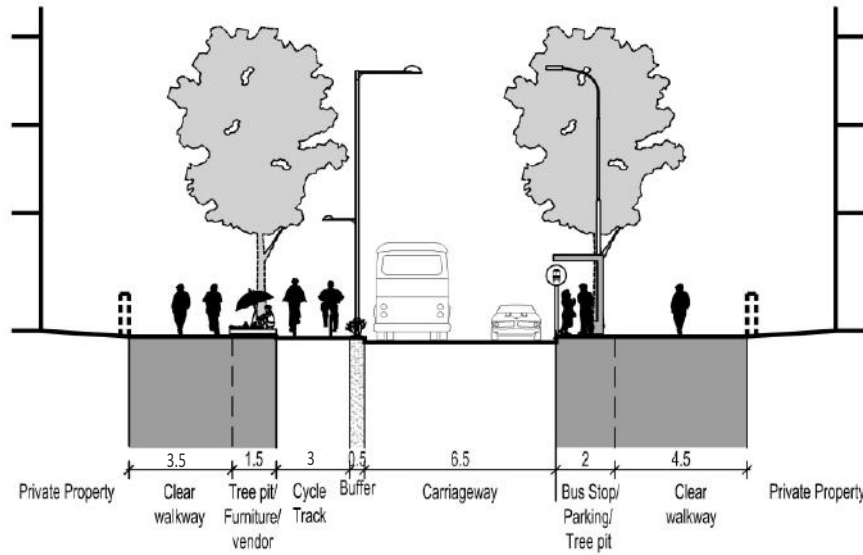

Section through Bus stop

Elements of Street	Type/Composition	Surrounding Land use/Activity
Footpath	Both Sides	Residential Neighbourhood
Cycle Track	One Side	Commercial/Mixed use (high pedestrian footfall)
Carriageway	Two Way, Undivided	Institutional
Parallel Parking	Yes	Special Streets
Street Vending	High Demand	Through Traffic

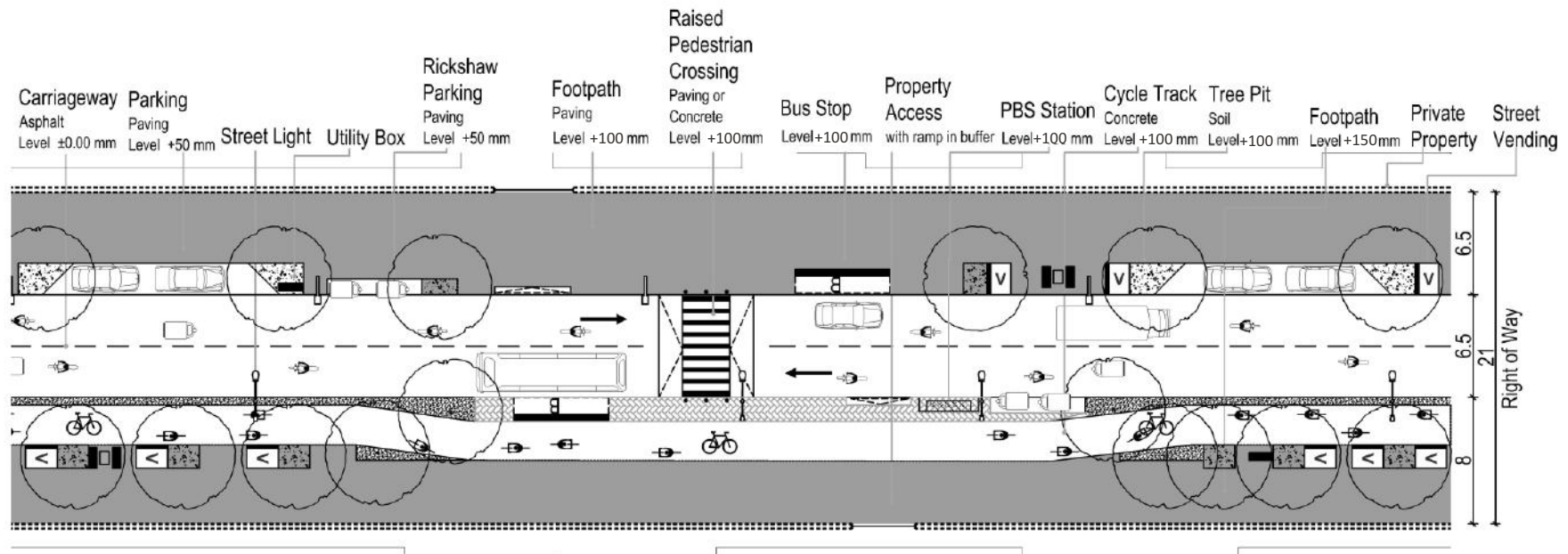

21B

21 MTS. RIGHT OF WAY-B

Recommended for streets with through traffic alongside educational institutes, schools, colleges and parking requirements.

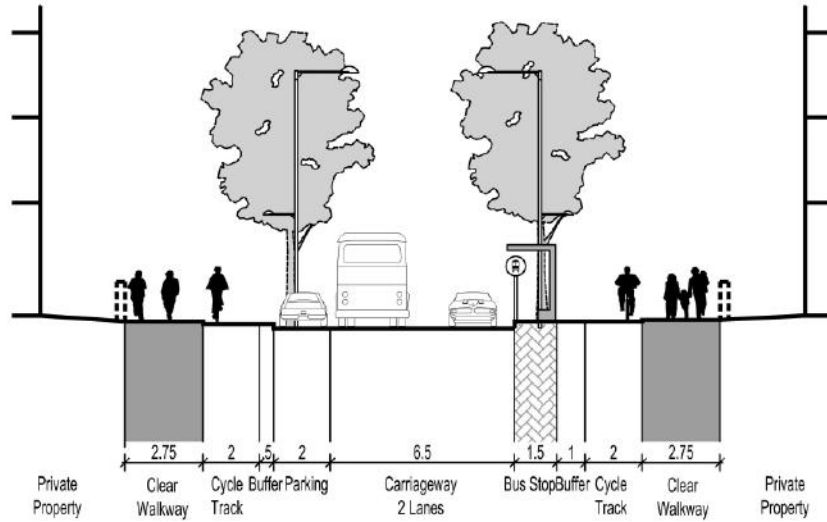

Elements of Street	Type/Composition	Surrounding Land use/Activity
Footpath	Both Side	Residential Neighbourhood
Cycle Track	Both Side	Commercial
Carriageway	Two Way, Undivided	Institutional
Parallel Parking	Yes	Special Streets
Street Vending	Low Demand	Through Traffic

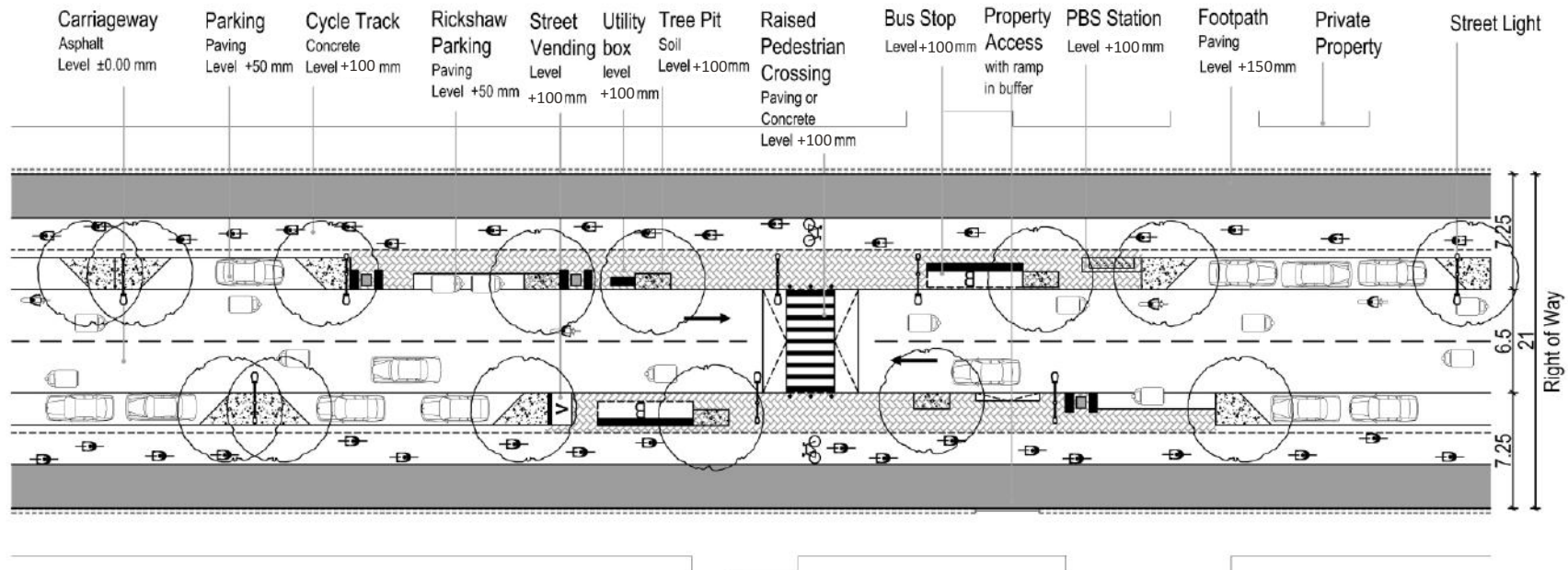

21C

21 MTS. RIGHT OF WAY-C

Recommended for streets with through traffic and parking requirements

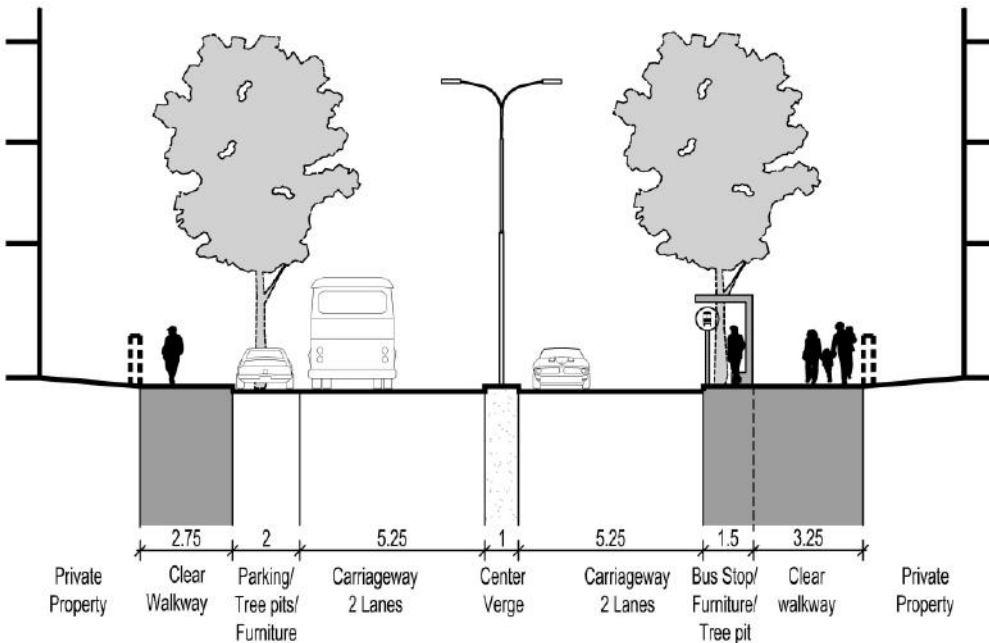

Elements of Street	Type/Composition
Footpath	Both Sides
Cycle Track	---
Carriageway	Two Way, divided
Parallel Parking	Yes
Street Vending	Medium Demand

Surrounding Land use/Activity
Residential Neighbourhood
Commercial
Institutional
Special Streets
Through Traffic

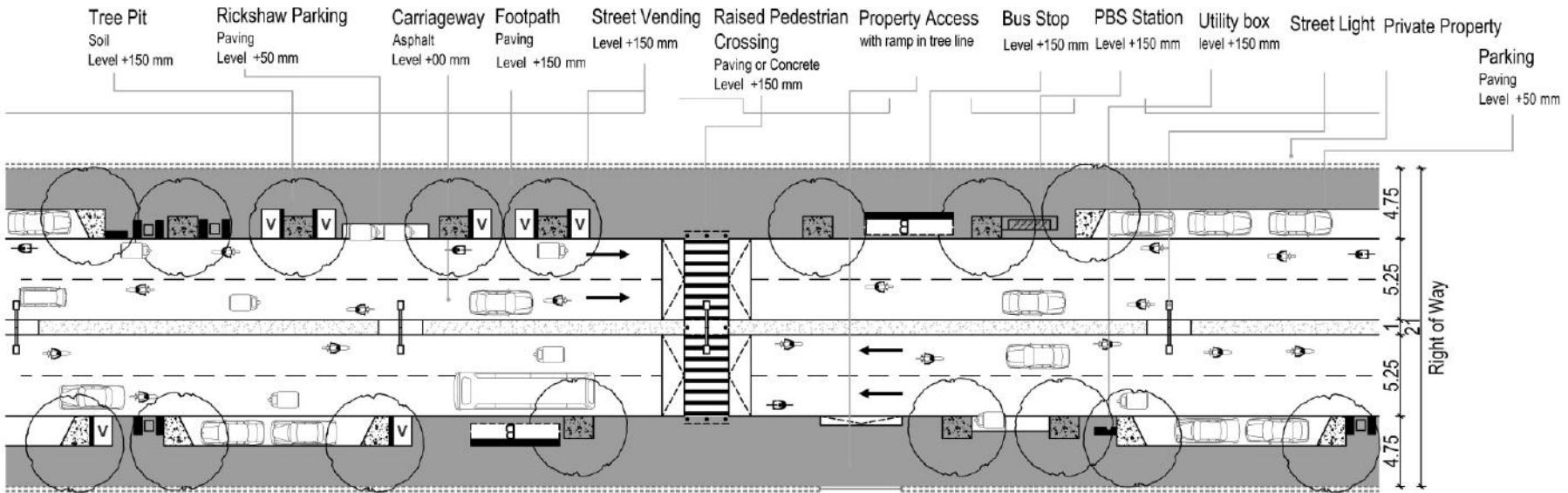

21D

21 MTS. RIGHT OF WAY- D

Recommended for streets with heavy through traffic, such as mobility corridors

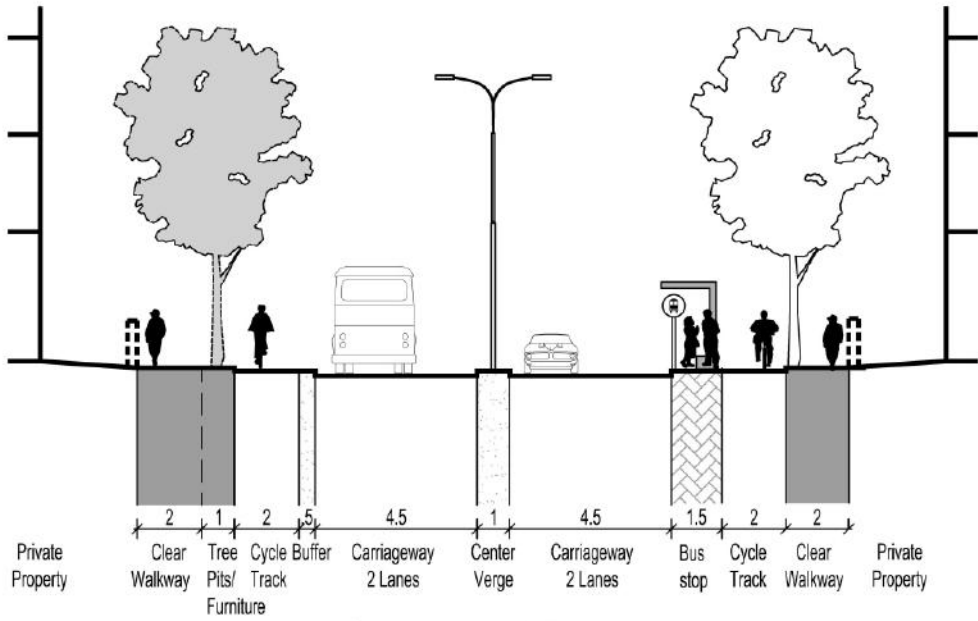

Section through Bus stop

Elements of Street	Type/Composition
Footpath	Both Sides
Cycle Track	Both Sides
Carriageway	Two Way, Divided
Parallel Parking	---
Street Vending	Low Demand

Surrounding Land use/Activity
Residential Neighbourhood
Commercial
Institutional
Special Streets
Through Traffic

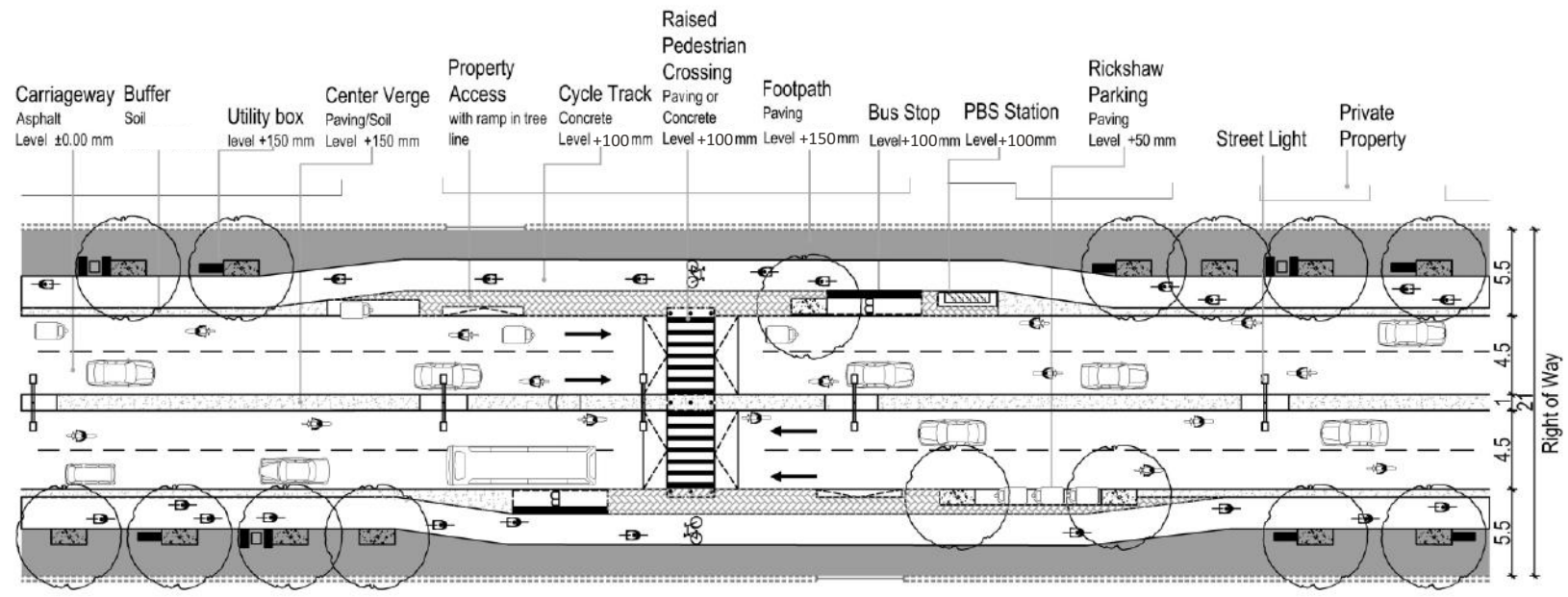

24A

24 MTS. RIGHT OF WAY- A

Recommended for streets with heavy through traffic, such as mobility corridors

Elements of Street	Type/Composition	Surrounding Land use/Activity
Footpath	Both Side	Residential Neighbourhood
Cycle Track	Both Side	Commercial
Carriageway	Two Way, Divided	Institutional
Parallel Parking	---	Special Streets
Street Vending	Low Demand	Through Traffic

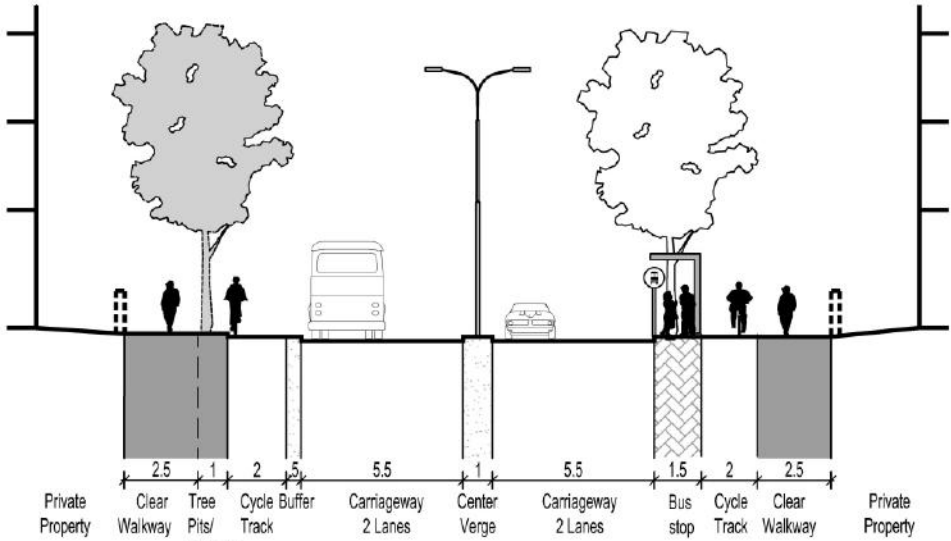

Section through Bus stop

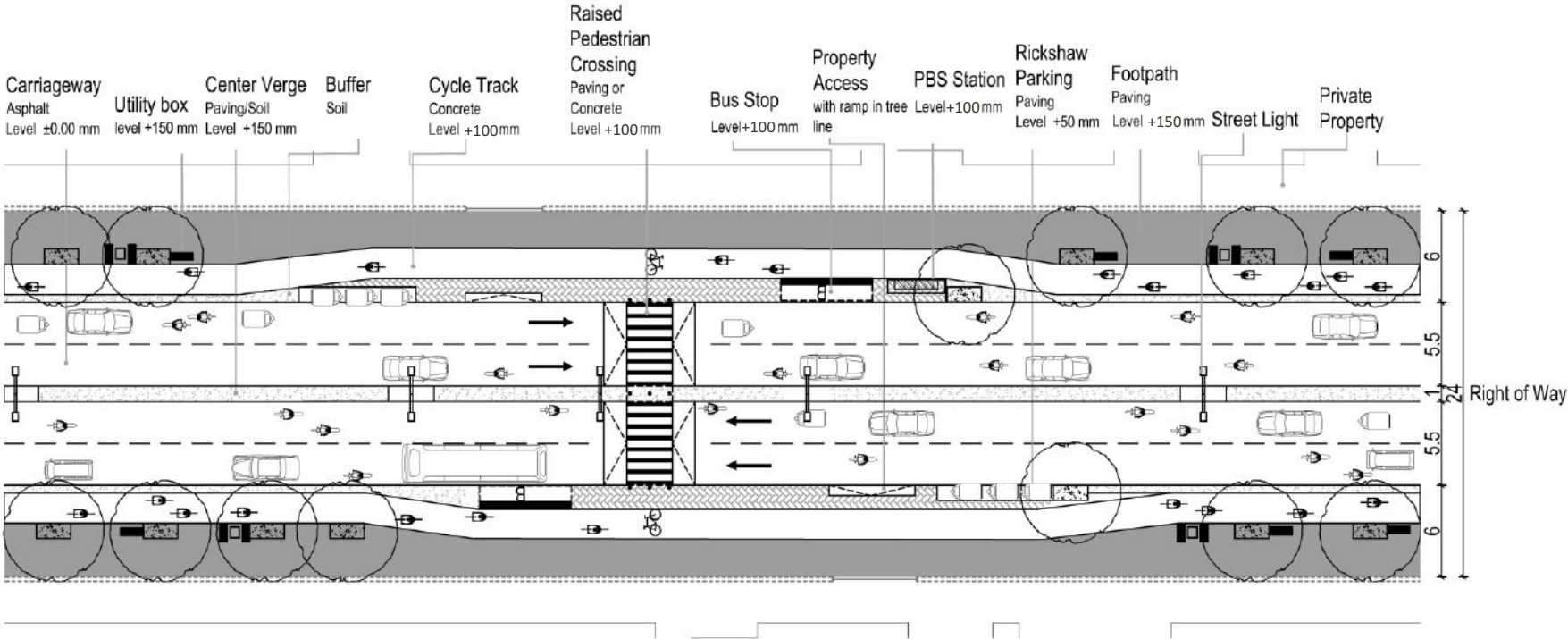

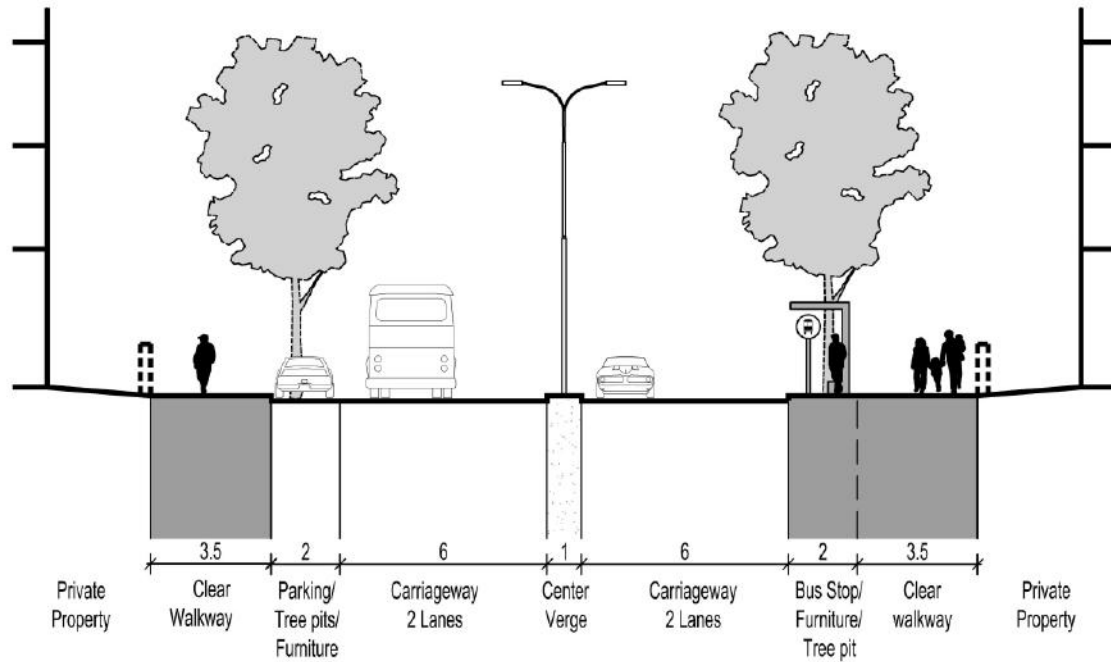

24 MTS. RIGHT OF WAY- B

24B

Recommended for streets with through traffic and parking requirements

Elements of Street	Type/Composition	Surrounding Land use/Activity
Footpath	Both Side	Residential Neighbourhood
Cycle Track	---	Commercial /Mixed use
Carriageway	Two Way, divided	Institutional
Parallel Parking	Yes	Special Streets
Street Vending	Low Demand	Through Traffic

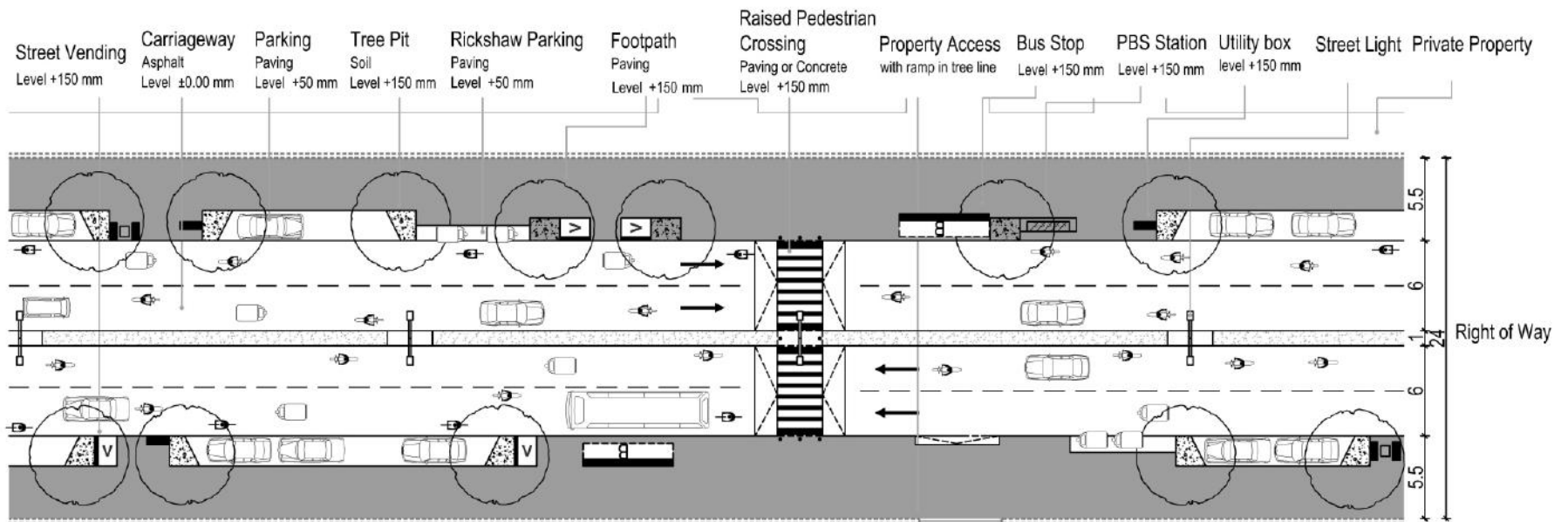

24C

24 MTS. RIGHT OF WAY- C

Recommended for streets with through traffic alongside educational institutes, schools, colleges and parking requirements.

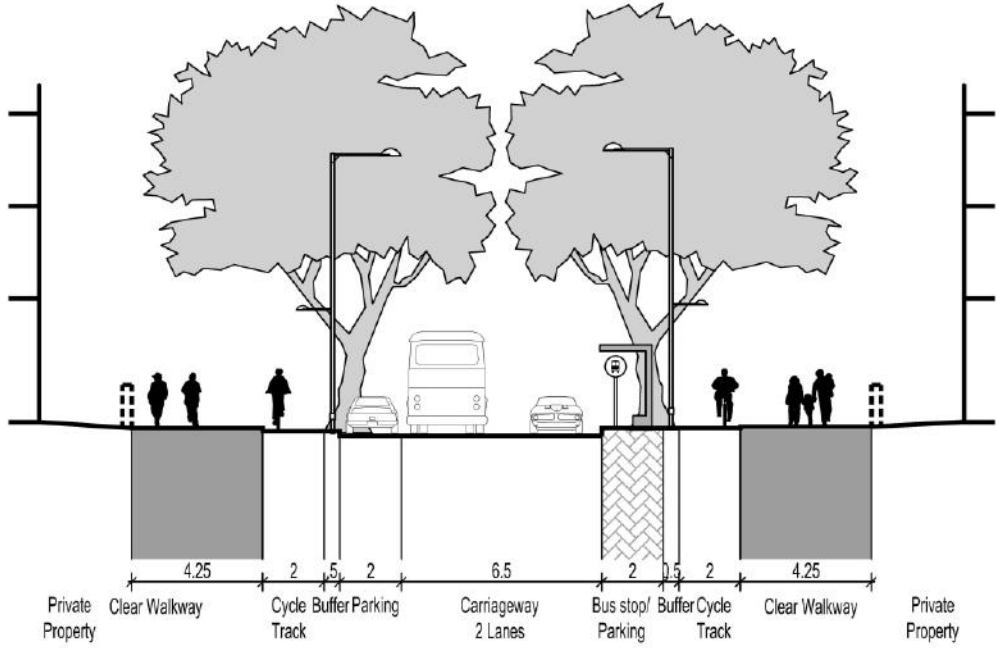

Section through Bus stop

Elements of Street	Type/Composition	Surrounding Land use/Activity
Footpath	Both Sides	Residential Neighbourhood
Cycle Track	Both Sides	Commercial /Mixed Use
Carriageway	Two Way, Undivided	Institutional
Parallel Parking	Yes	Special Streets
Street Vending	Low Demand	Through Traffic

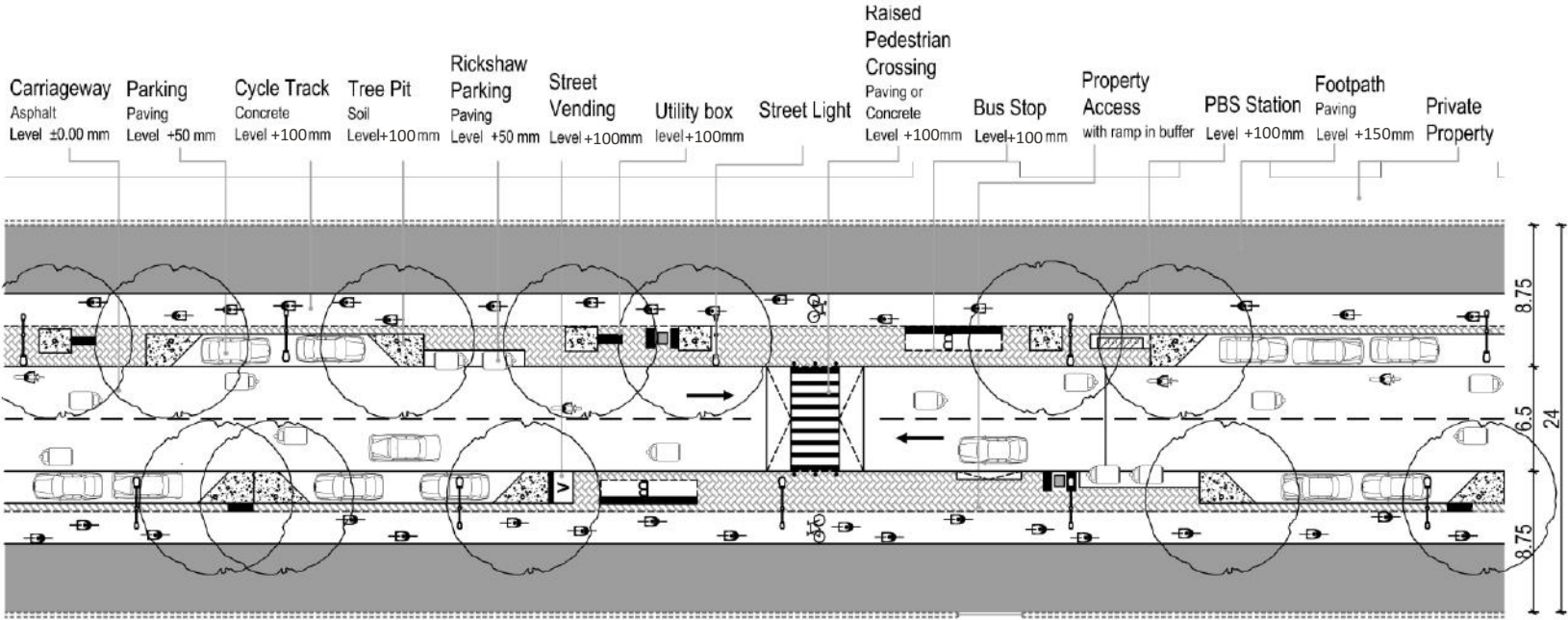

Right of Way

24 MTS. RIGHT OF WAY- BRT

Recommended for mobility corridors with through traffic

24 BRT

Elements of Street	Type/Composition	Surrounding Land use/Activity
Footpath	Both Side	Residential Neighbourhood
Cycle Track	Yes	Commercial
Carriageway	Two Way, Divided, Central BRT lane	Institutional
Parallel Parking	Yes	Special Streets
Street Vending	Low Demand	Through Traffic (Mobility Corridor)

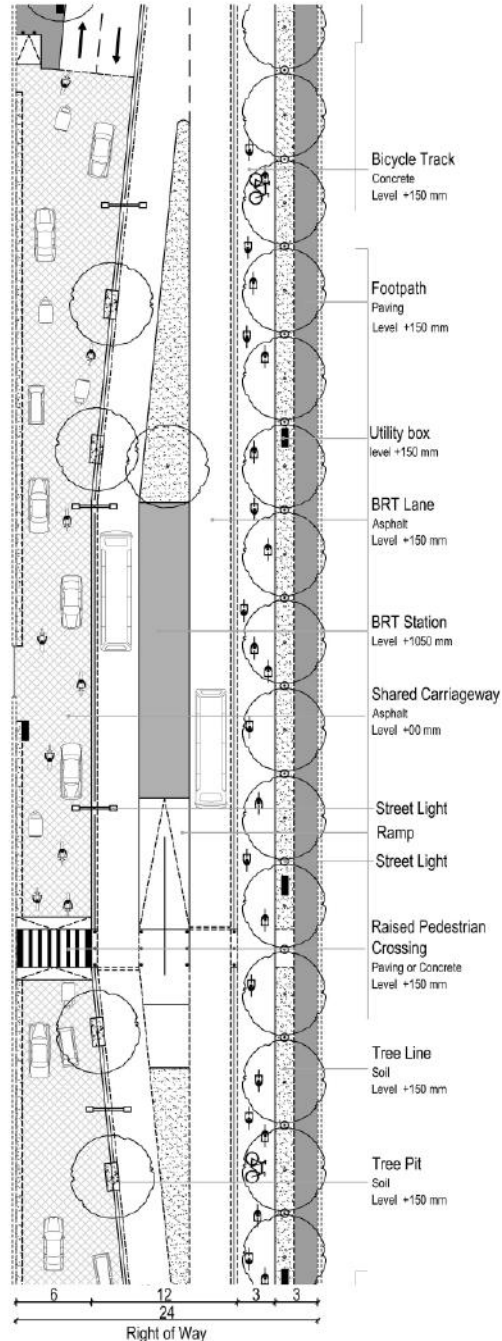
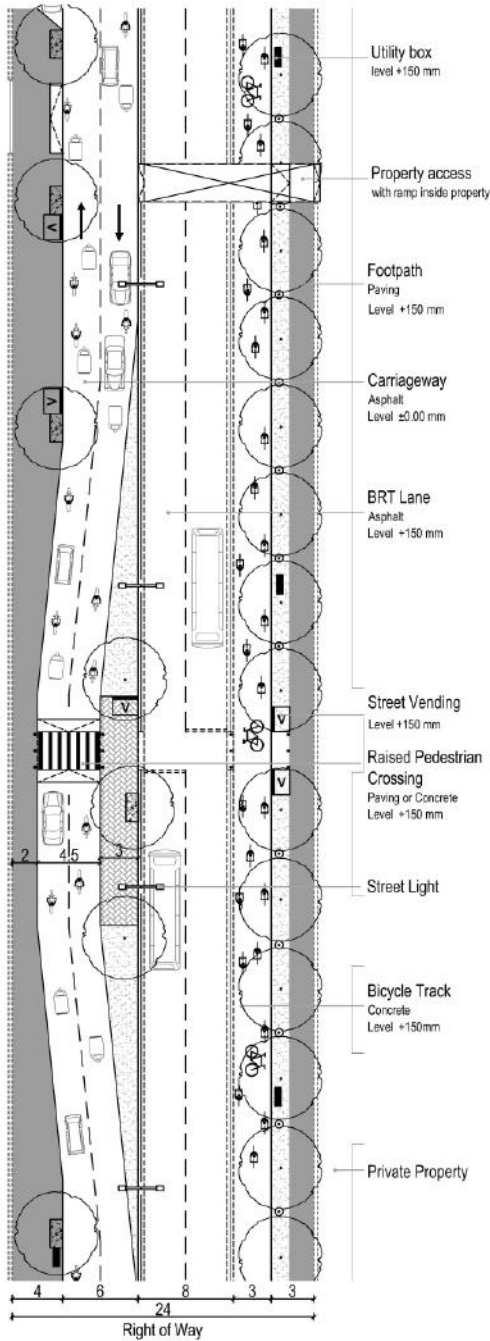
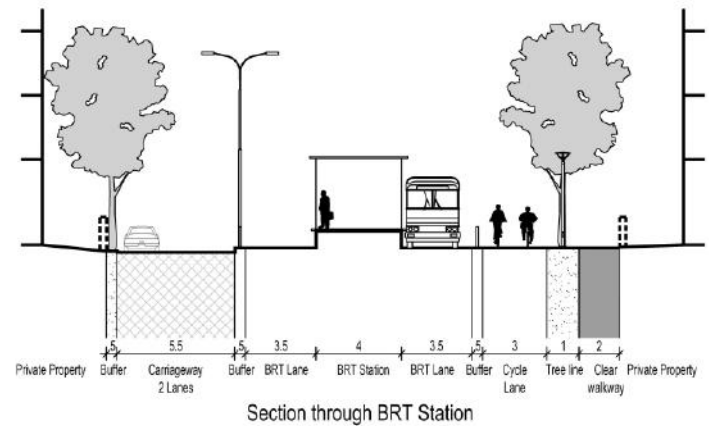
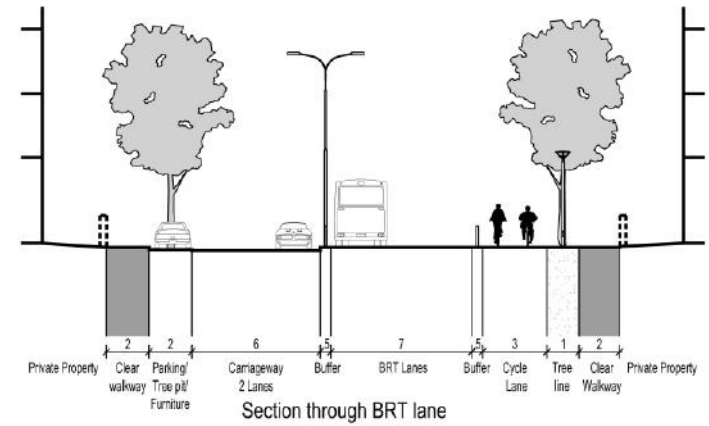

27

27 MTS. RIGHT OF WAY

Recommended for streets alongside educational institutes, schools, colleges and with through traffic

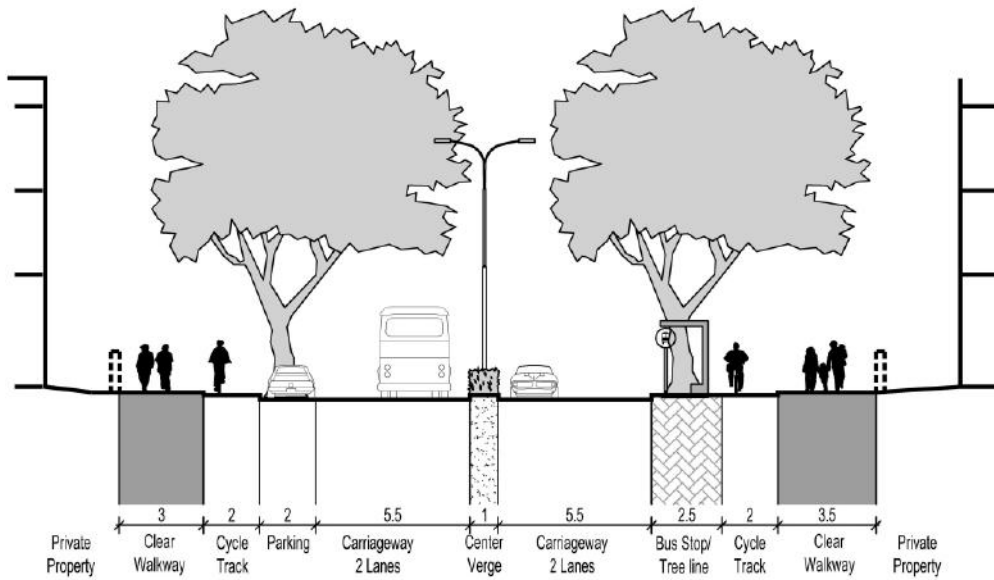

Elements of Street	Type/Composition	Surrounding Land use/Activity
Footpath	Both Sides	Residential Neighbourhood
Cycle Track	Both Sides	Commercial
Carriageway	Two Way, Divided	Institutional
Parallel Parking	Yes	Special Streets
Street Vending	Low Demand	Through Traffic

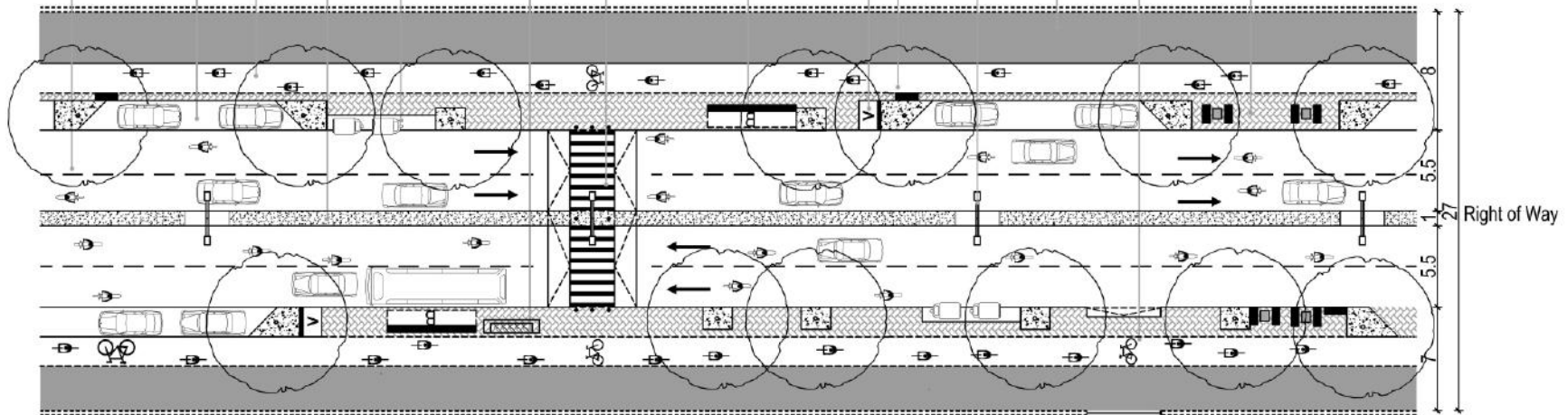

30A

30 MTS. RIGHT OF WAY- A

Recommended for streets with heavy through traffic

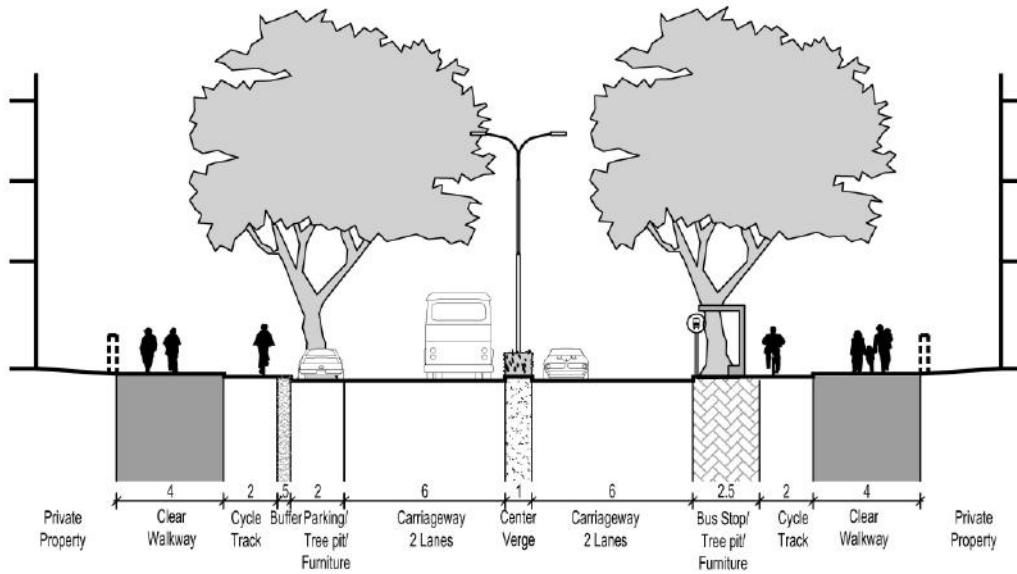

Elements of Street	Type/Composition
Footpath	Both Sides
Cycle Track	Both Sides
Carriageway	Two Way, Divided
Parallel Parking	Yes
Street Vending	Low Demand

Surrounding Land use/Activity
Residential Neighbourhood
Commercial / Mixed use
Institutional
Special Streets
Through Traffic

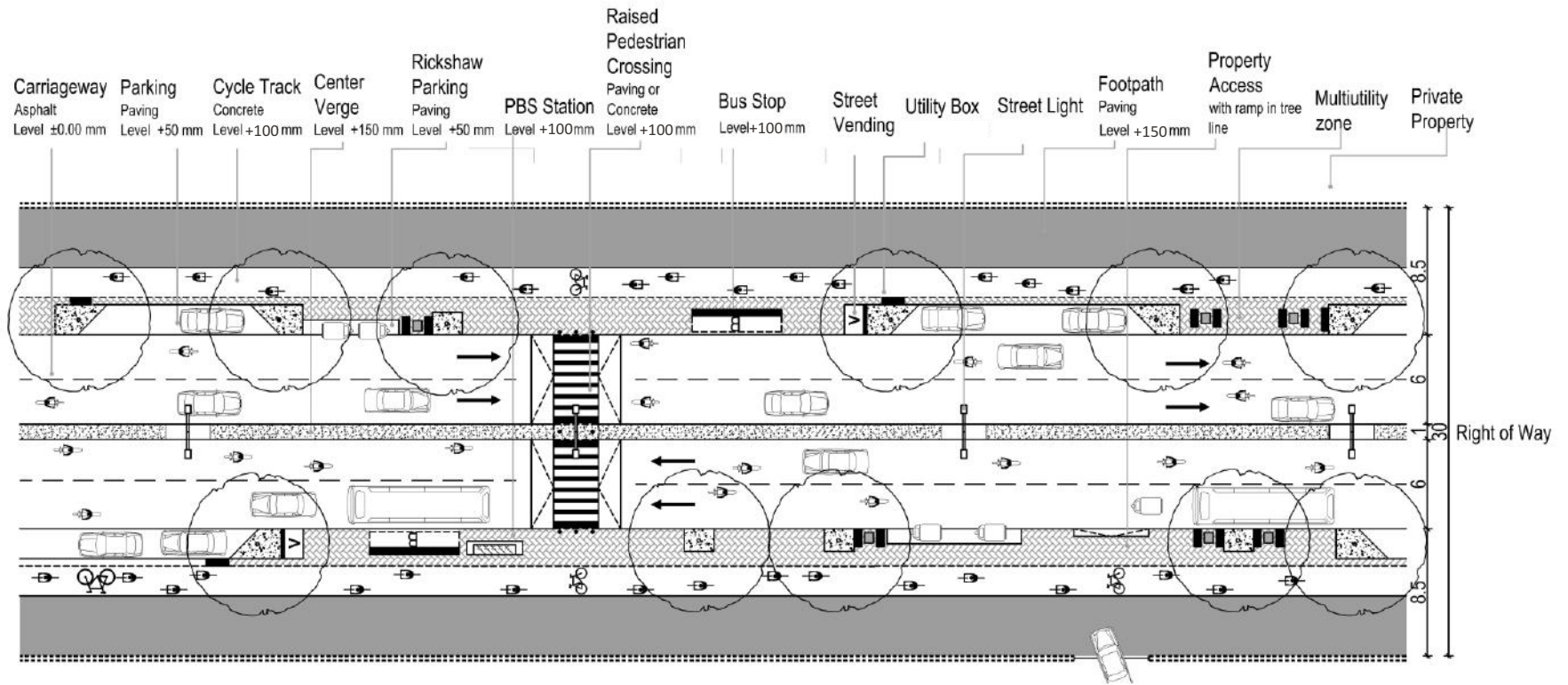

30B

30 MTS. RIGHT OF WAY- B

Recommended for streets with through traffic and vending activities

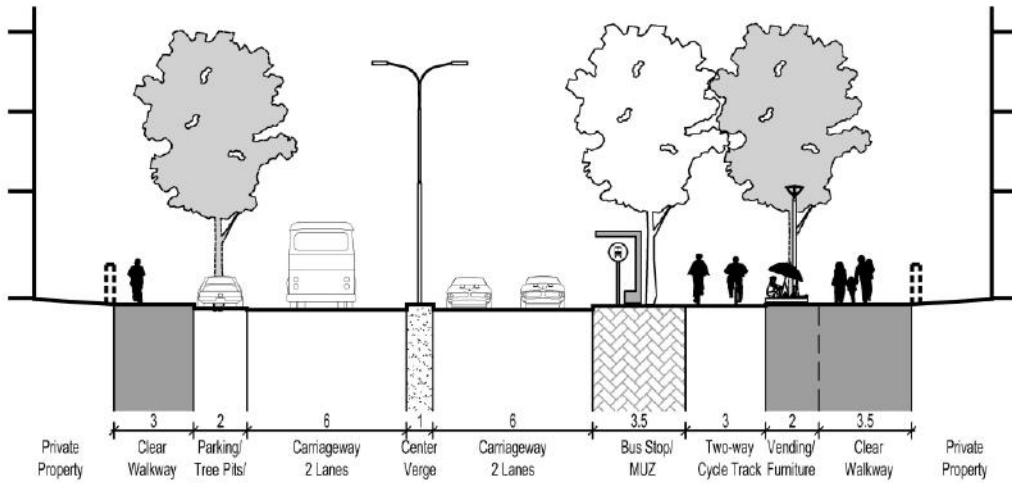

Section through Bus stop

Elements of Street	Type/Composition
Footpath	Both Sides
Cycle Track	One Side
Carriageway	Two Way, Divided
Parallel Parking	Yes
Street Vending	High Demand

Surrounding Land use/Activity
Residential Neighbourhood
Commercial / Mixed use
Institutional
Special Streets
Through Traffic

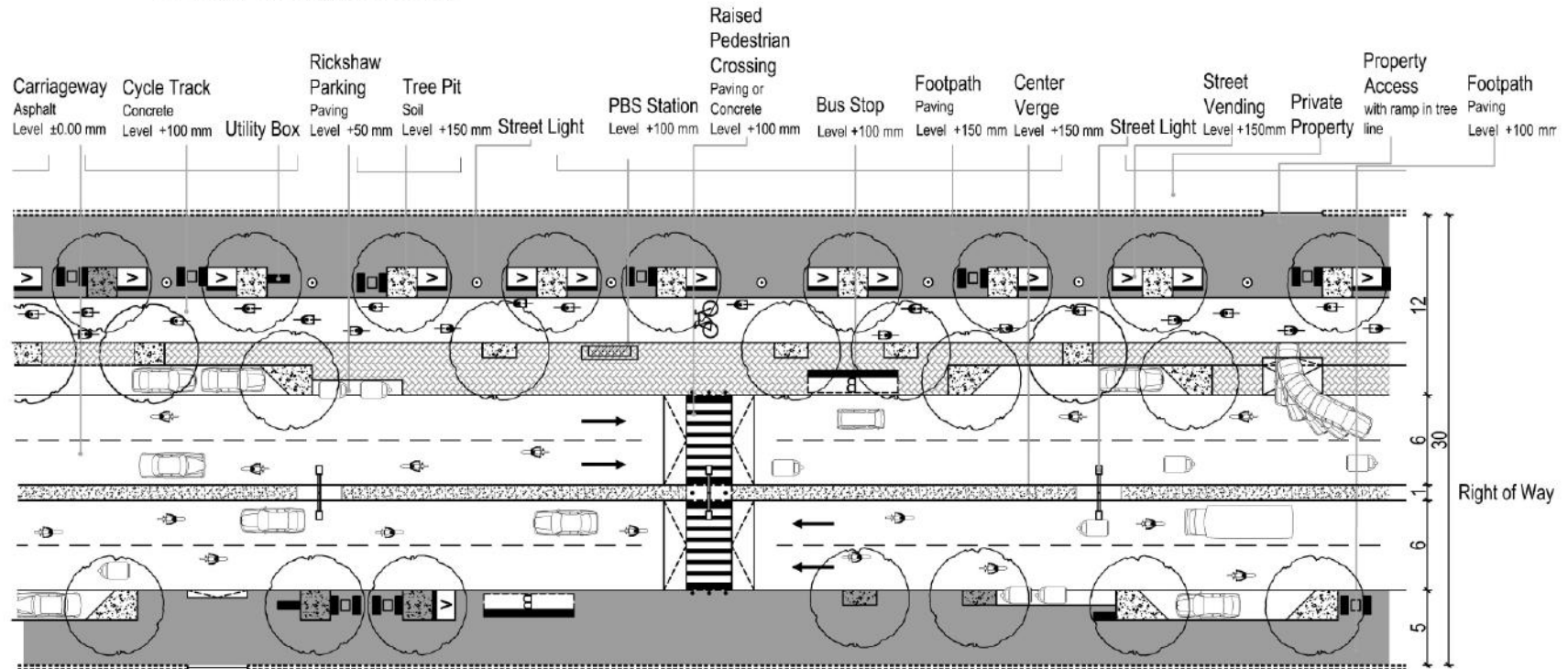

30 BRT

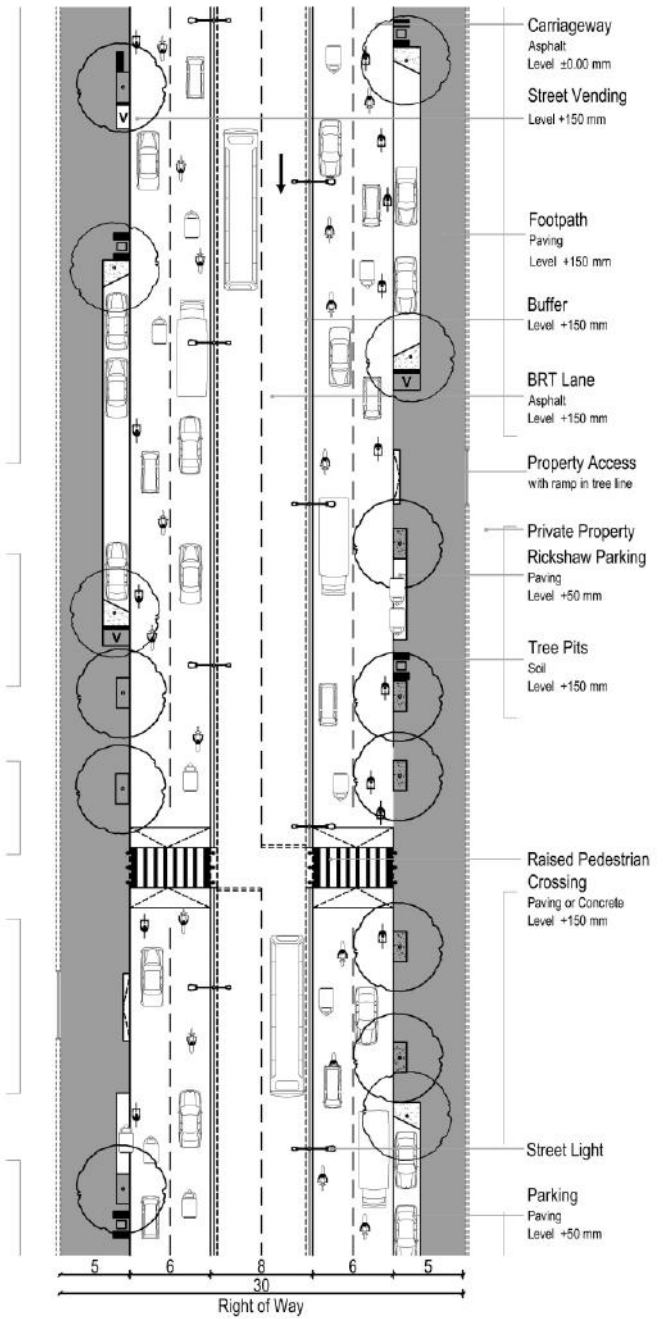

Plan of BRT Lane

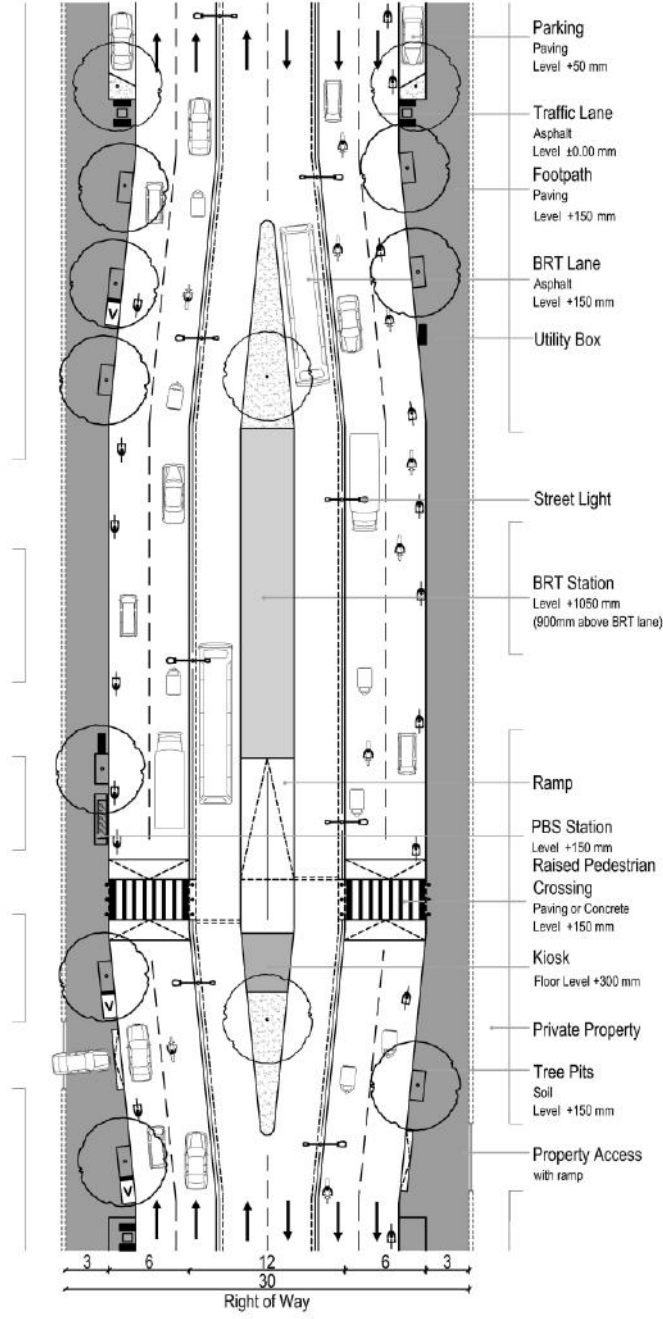

Plan of BRT Station

30 MTS. RIGHT OF WAY- BRT

Recommended for mobility corridors with through traffic

30 BRT

Elements of Street	Type/Composition	Surrounding Land use/Activity
Footpath	Both Side	Residential Neighbourhood
Cycle Track	---	Commercial /Mixed Use
Carriageway	Two Way, Divided, Central BRT lane	Institutional
Parallel Parking	Yes	Special Streets
Street Vending	Low Demand	Through Traffic (Mobility Corridor)

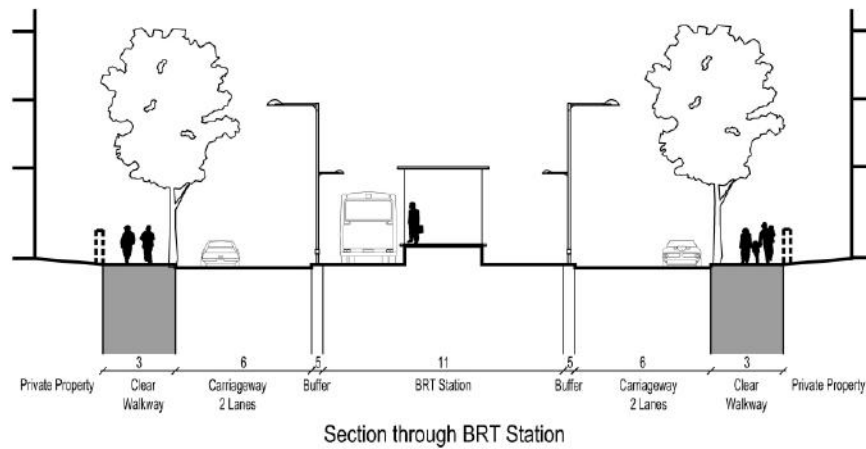
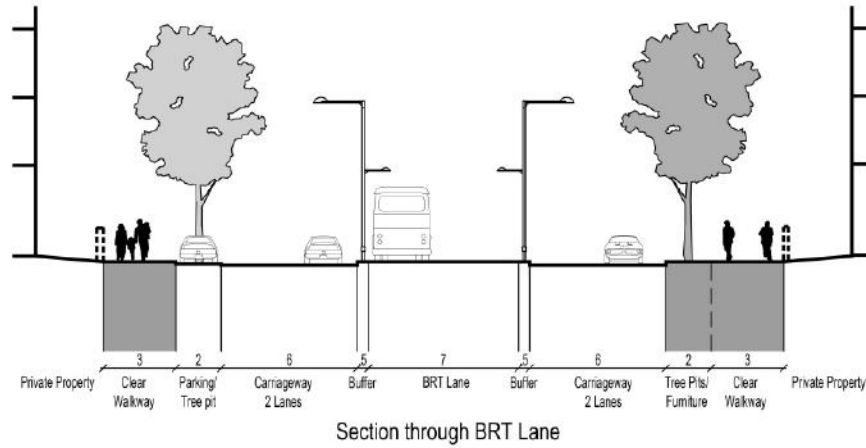

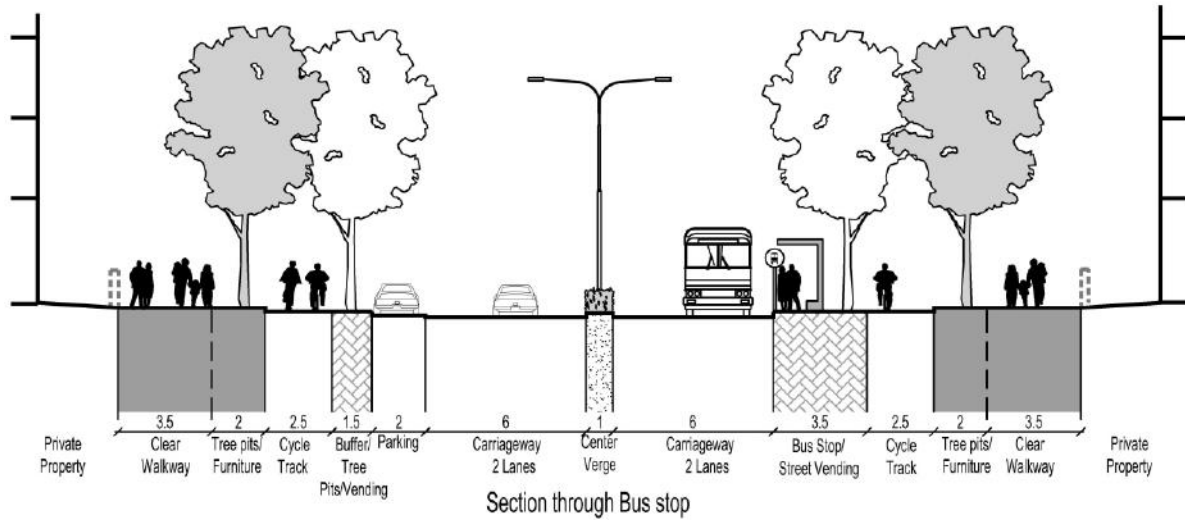

36 MTS. RIGHT OF WAY- A
Recommended for streets with through traffic

36A

Elements of Street	Type/Composition	Surrounding Land use/Activity
Footpath	Both Sides	Residential Neighbourhood
Cycle Track	Both Sides	Commercial
Carriageway	Two Way, Divided	Institutional
Parallel Parking	Yes	Special Streets
Street Vending	Medium Demand	Through Traffic

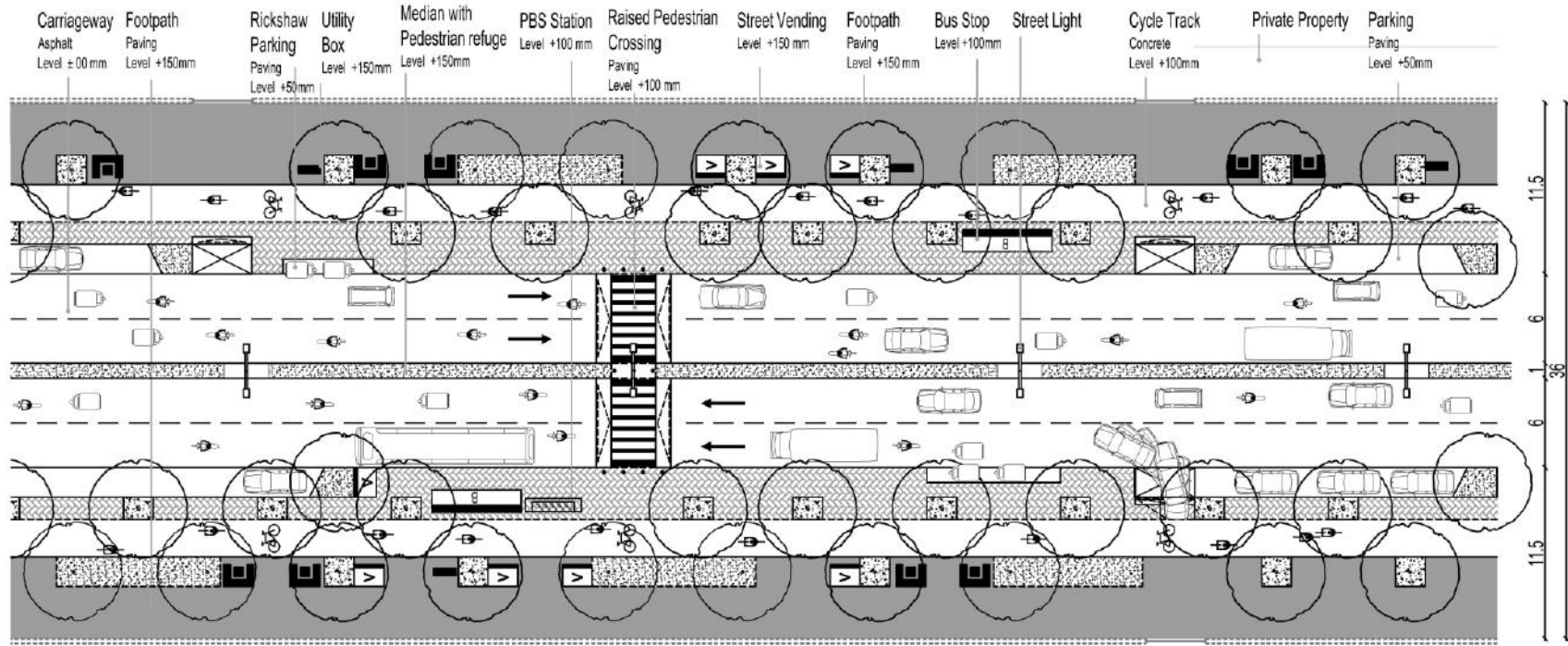

36B

36 MTS. RIGHT OF WAY-B

Recommended for streets with service lanes and through traffic

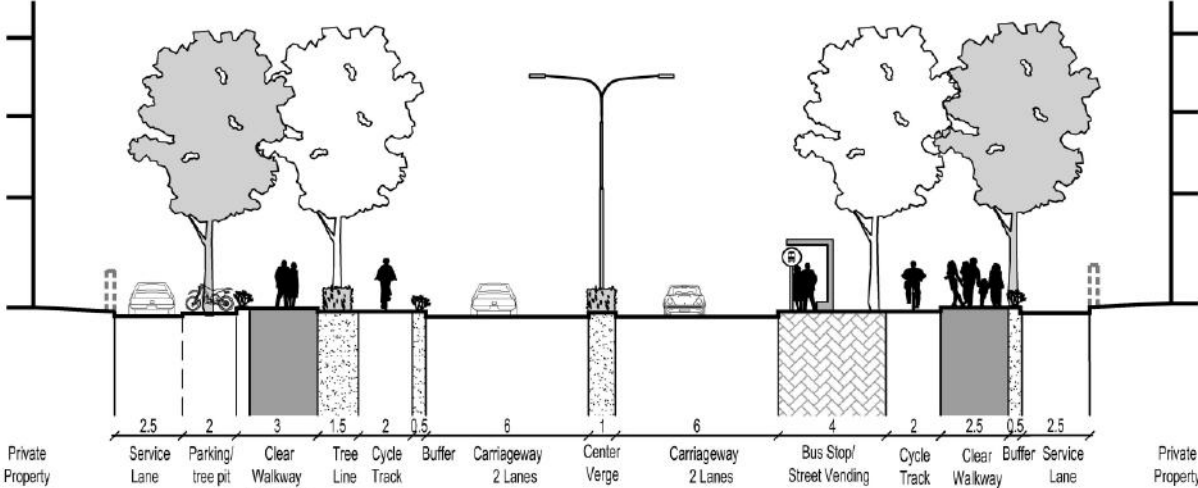

Elements of Street	Type/Composition	Surrounding Land use/Activity
Footpath	Both Side	Residential Neighbourhood
Cycle Track	Both Side	Commercial / Mixed Use
Carriageway	Two Way, Divided , Service lane	Institutional
Parallel Parking	Yes	Special Streets
Street Vending	Medium Demand	Through Traffic

Section through Bus stop

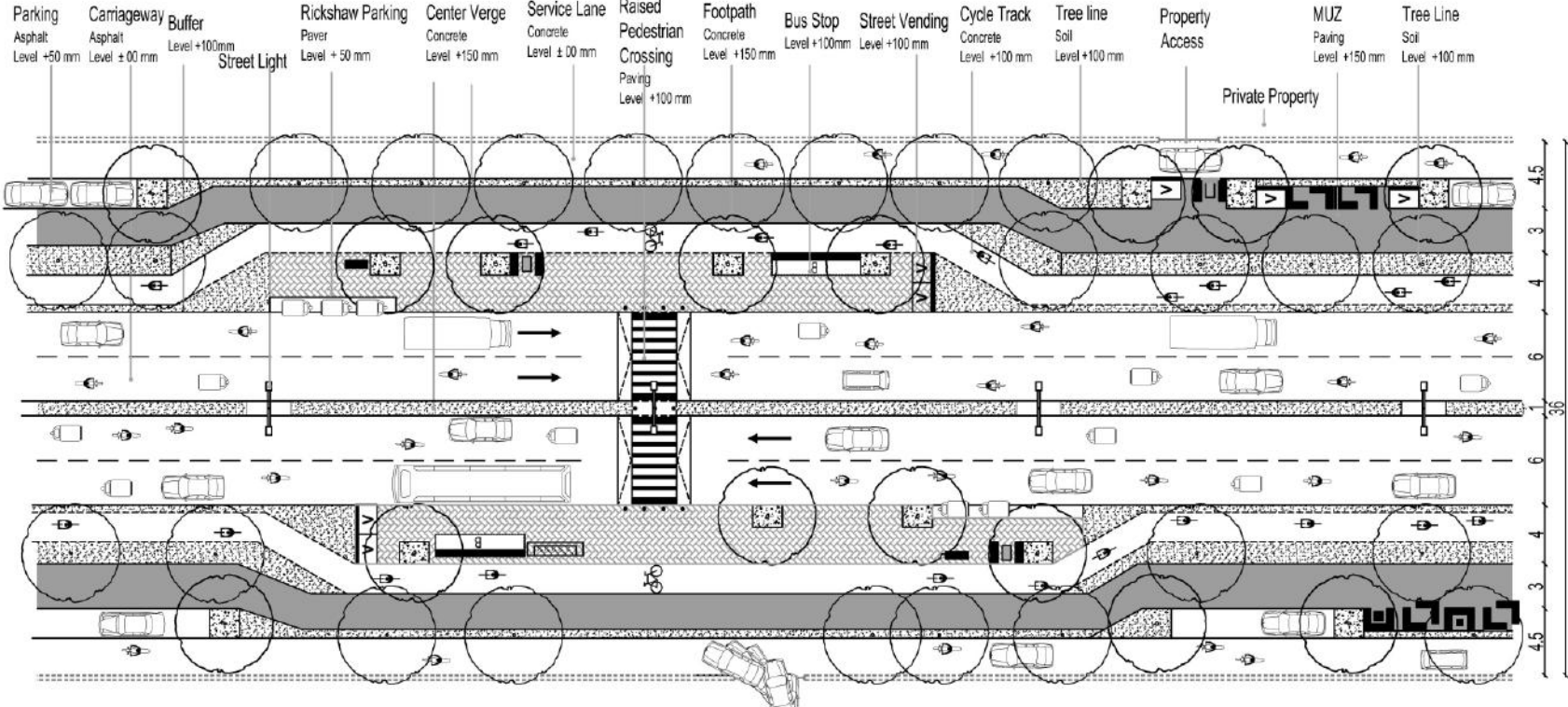

36 BRT

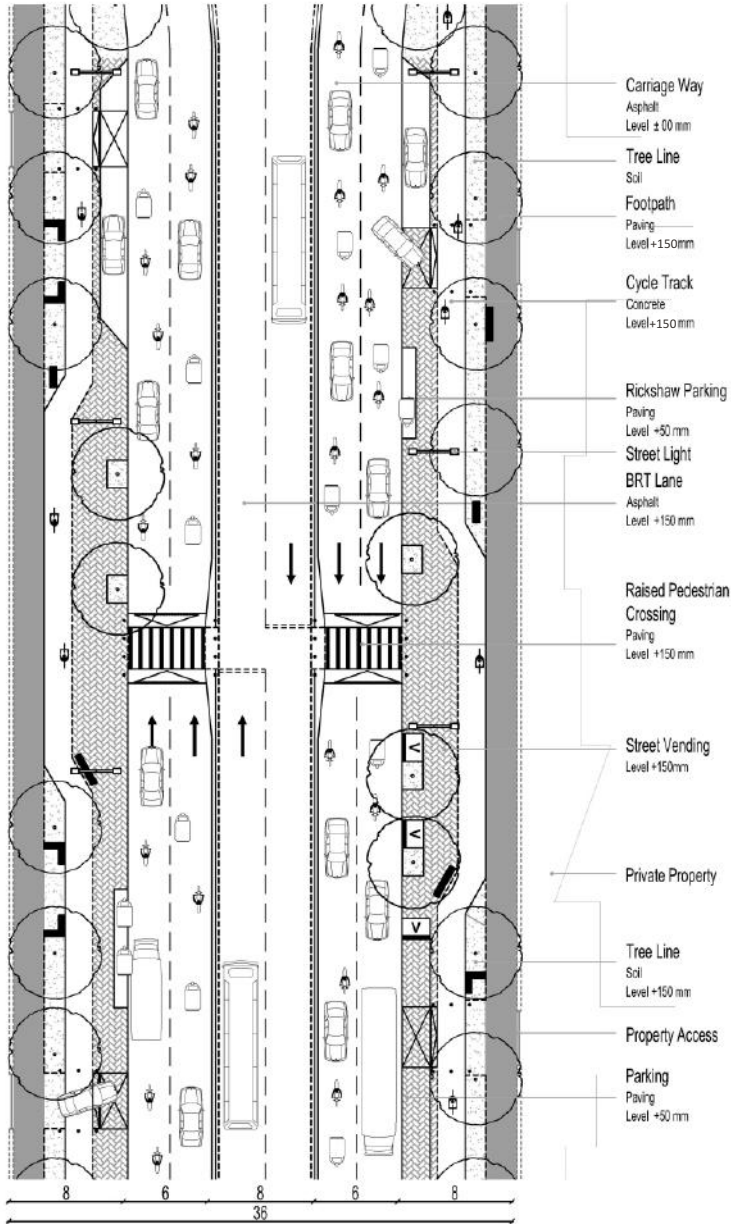

Plan of BRT lane

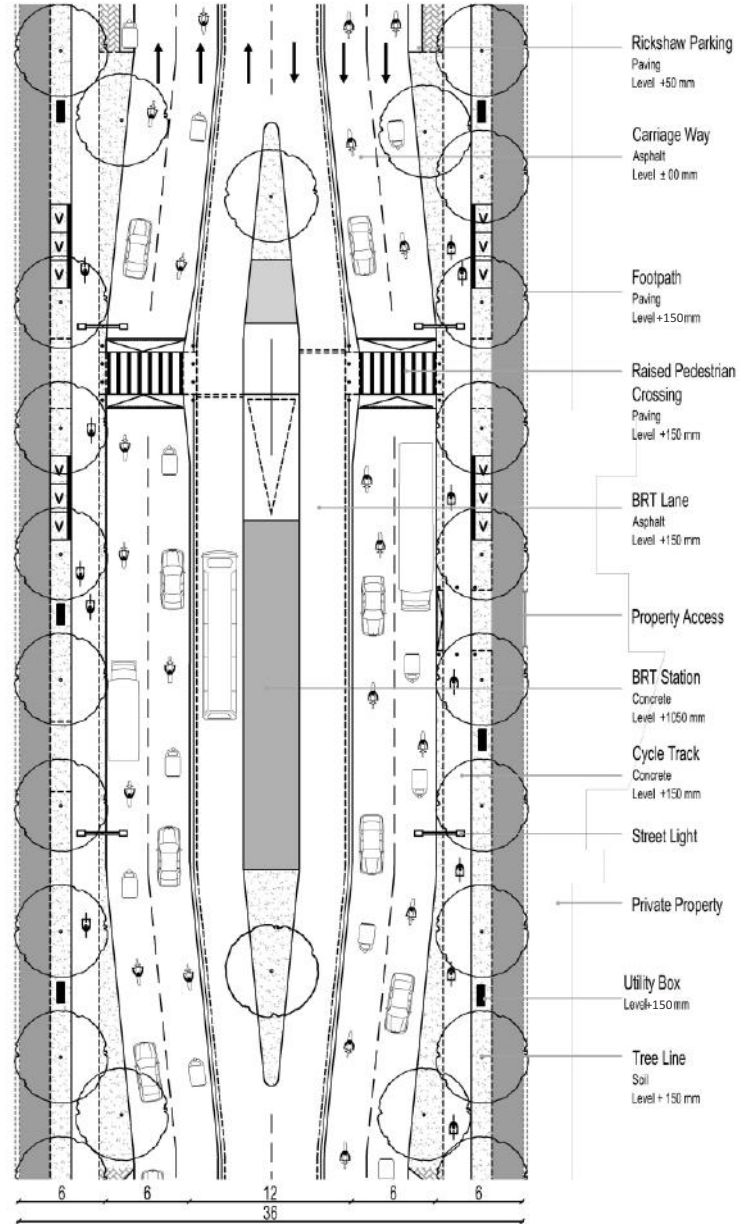

Plan of BRT Station

36 MTS. RIGHT OF WAY-BRT

Recommended for streets with through traffic such as mobility corridors

36 BRT

Elements of Street	Type/Composition	Surrounding Land use/Activity
Footpath	Both Side	Residential Neighbourhood
Cycle Track	Both Side	Commercial
Carriageway	Two Way, Divided, Central BRT lane	Institutional
Parallel Parking	Yes	Special Streets
Street Vending	Low Demand	Through Traffic (Mobility Corridor)

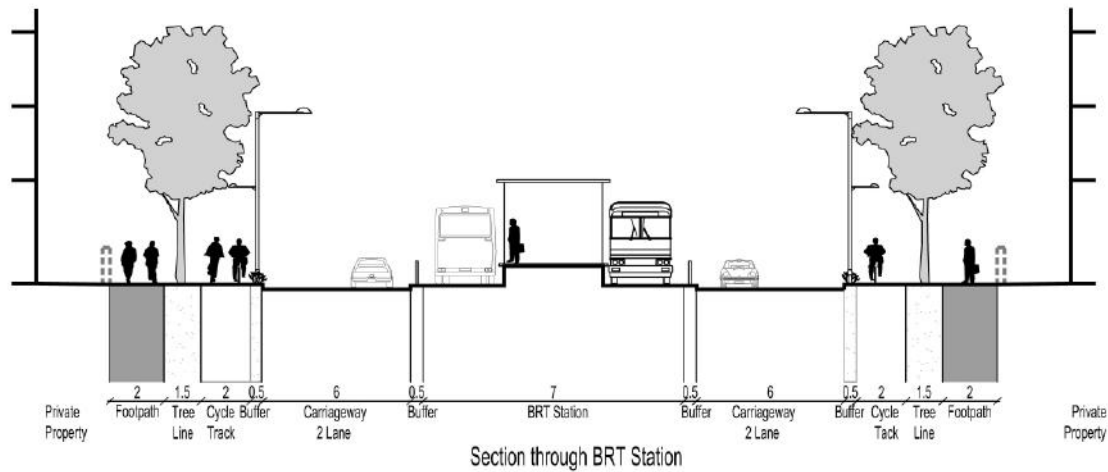
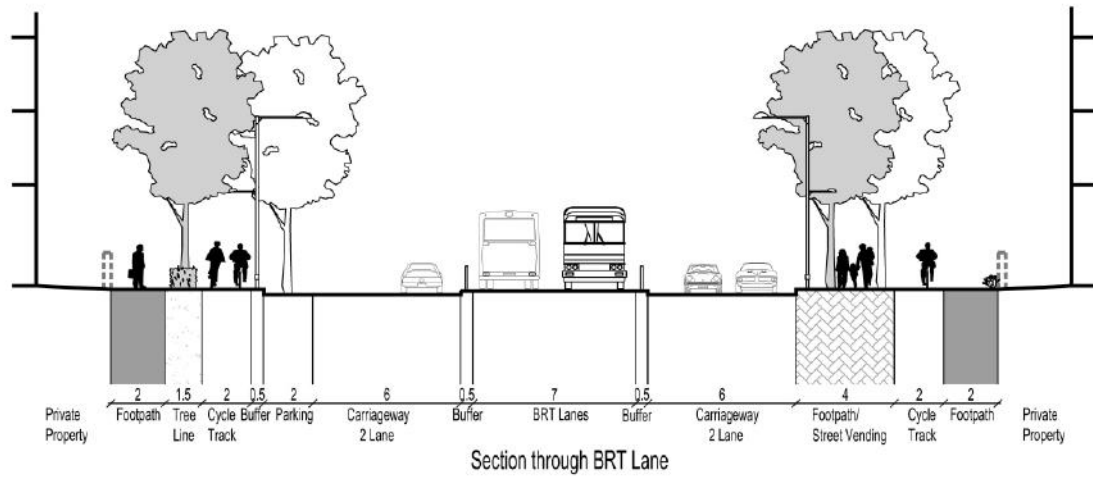

42A

42 MTS. RIGHT OF WAY- A
Recommended for streets with through traffic

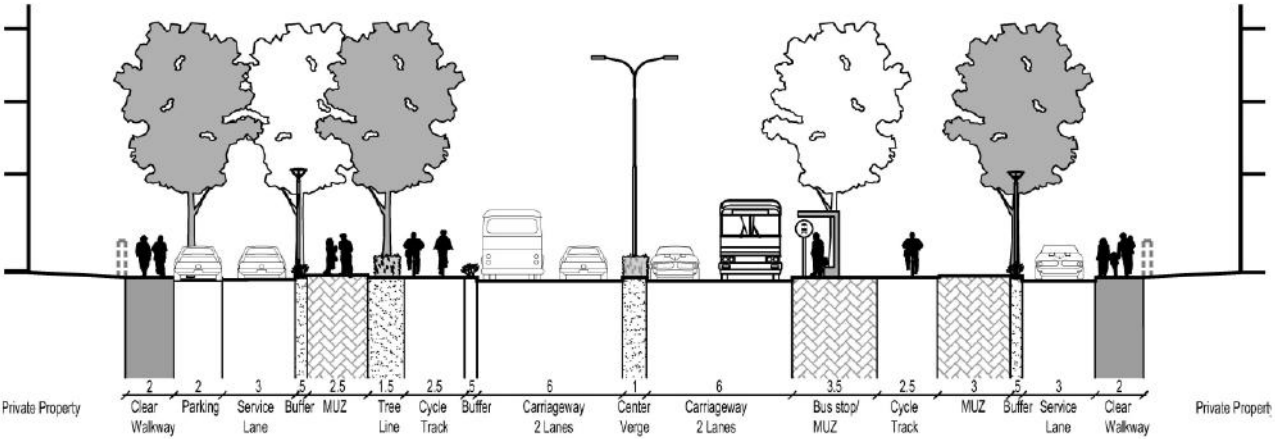

Elements of Street	Type/Composition	Surrounding Land use/Activity
Footpath	Both Side	Residential Neighbourhood
Cycle Track	Both Side	Commercial / Mixed use
Carriageway	Two Way, Divided with Service lane	Institutional
Parallel Parking	Yes	Special Streets
Street Vending	Low Demand	Through Traffic

Section through Bus Stop

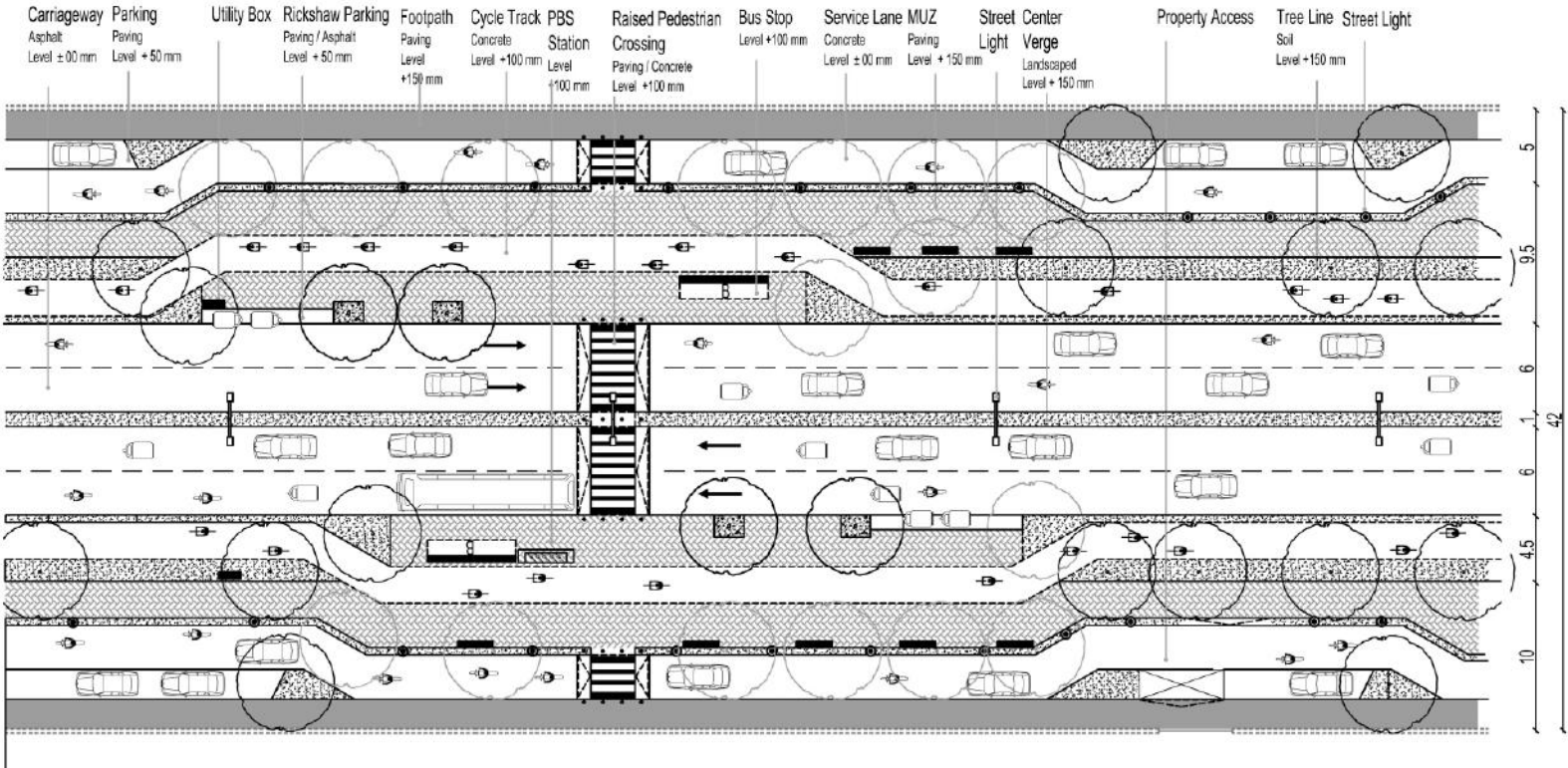

42B

42 MTS. RIGHT OF WAY-B

Recommended for streets with through traffic

Elements of Street	Type/Composition	Surrounding Land use/Activity
Footpath	Both Sides	Residential Neighbourhood
Cycle Track	Both Sides	Commercial
Carriageway	Two Way, Divided with Service lane	Institutional
Parallel Parking	Yes	Special Streets
Street Vending	Medium Demand	Through Traffic

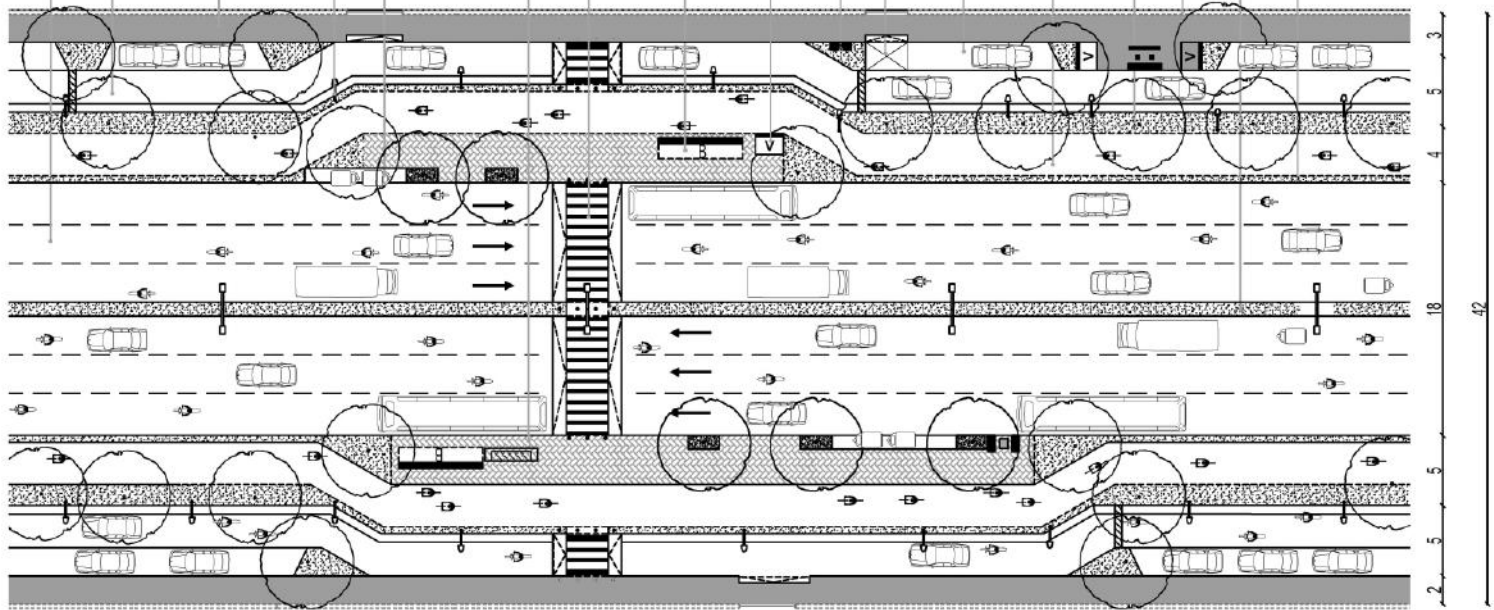
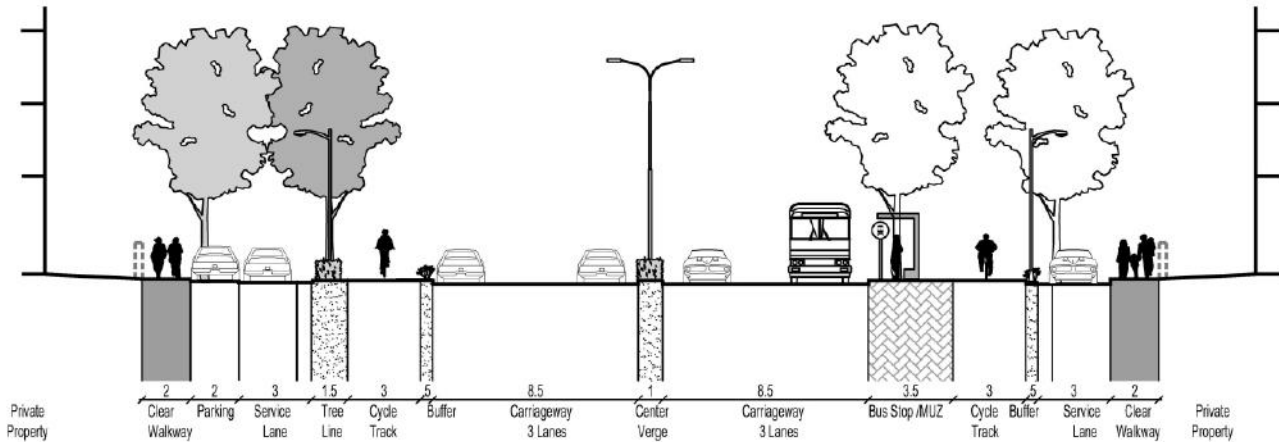

42 BRT

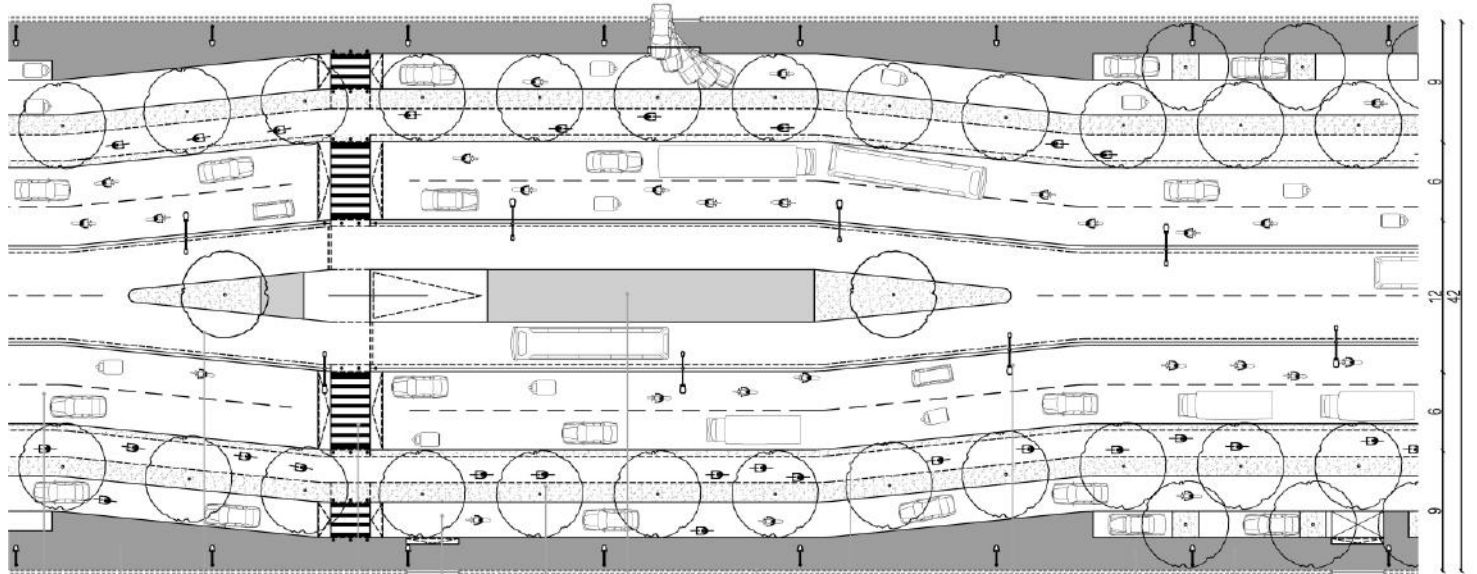

Carriage Way Asphalt Level ±0.00 mm	Footpath Paving Level +150 mm	BRT Lane Asphalt Level +150 mm	Raised Pedestrian Crossing Paving Level +150 mm	Service lane Concrete Level ±0.00 mm	Tree Line Soil Level +150 mm	BRT Station Level +1050	Private Property	Bicycle Track Concrete Level +150 mm	Street Light	Street Vending	Parallel Parking Paving Level +30 mm	Property Access	Plan of BRT Station
---	-------------------------------------	--------------------------------------	---	--	------------------------------------	----------------------------	------------------	--	--------------	----------------	--	-----------------	---------------------

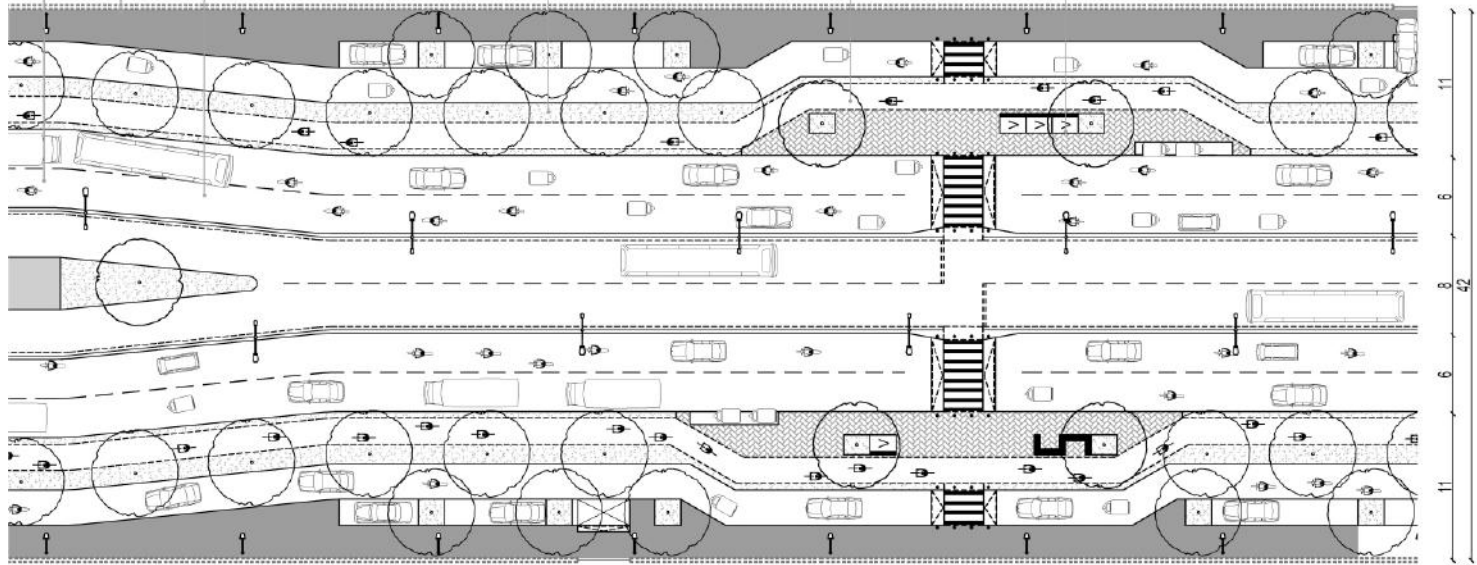

Plan of BRT lane

42 MTS. RIGHT OF WAY- BRT

Recommended for mobility corridors with through traffic

42 BRT

Elements of Street	Type/Composition	Surrounding Land use/Activity
Footpath	Both Side	Residential Neighbourhood
Cycle Track	Both Side	Commercial
Carriageway	Two Way, Divided, Central BRT lane	Institutional
Parallel Parking	Yes	Special Streets
Street Vending	Low Demand	Through Traffic (Mobility Corridor)

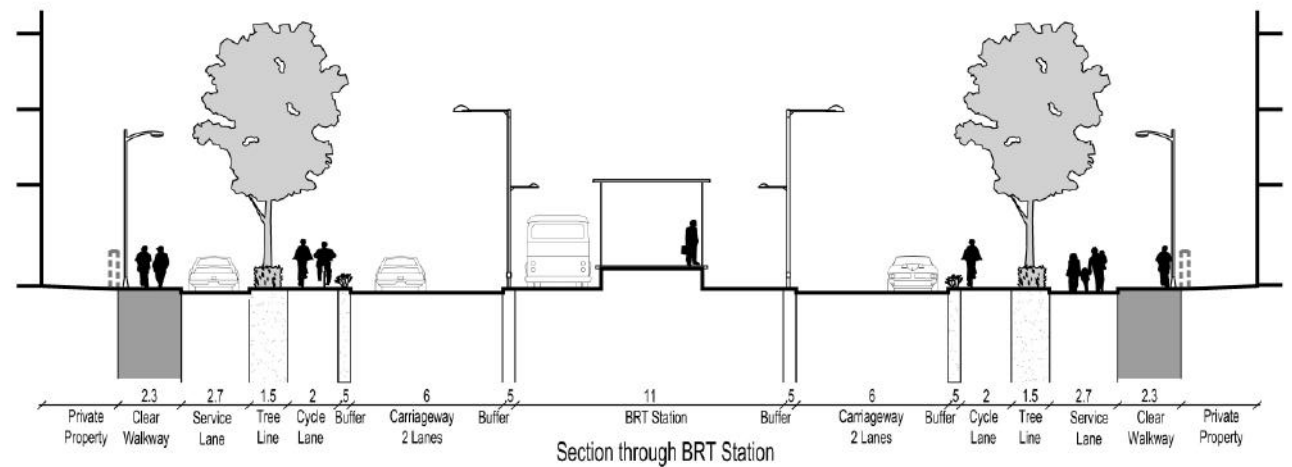

45

45 MTS. RIGHT OF WAY

Recommended for streets with through traffic

Elements of Street	Type/Composition
Footpath	Both Sides
Cycle Track	Both Sides
Carriageway	Two Way, Divided with Service lane
Parallel Parking	Yes
Street Vending	Medium Demand

Surrounding Land use/Activity
Residential Neighbourhood
Commercial
Institutional
Special Streets
Through Traffic

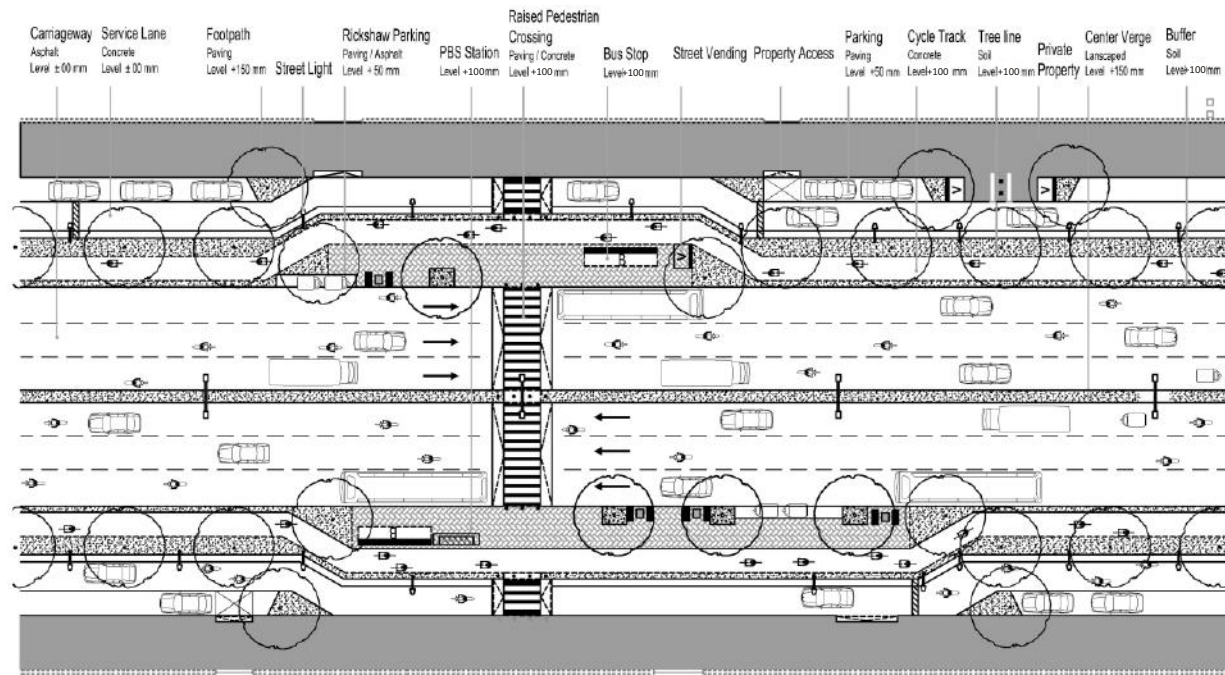
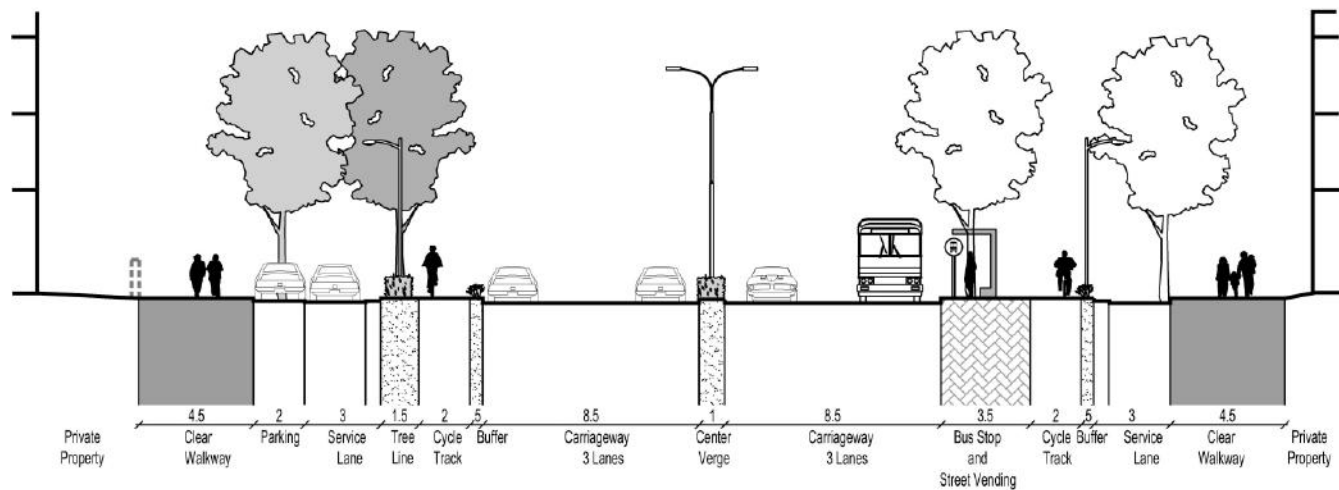

45 BRT

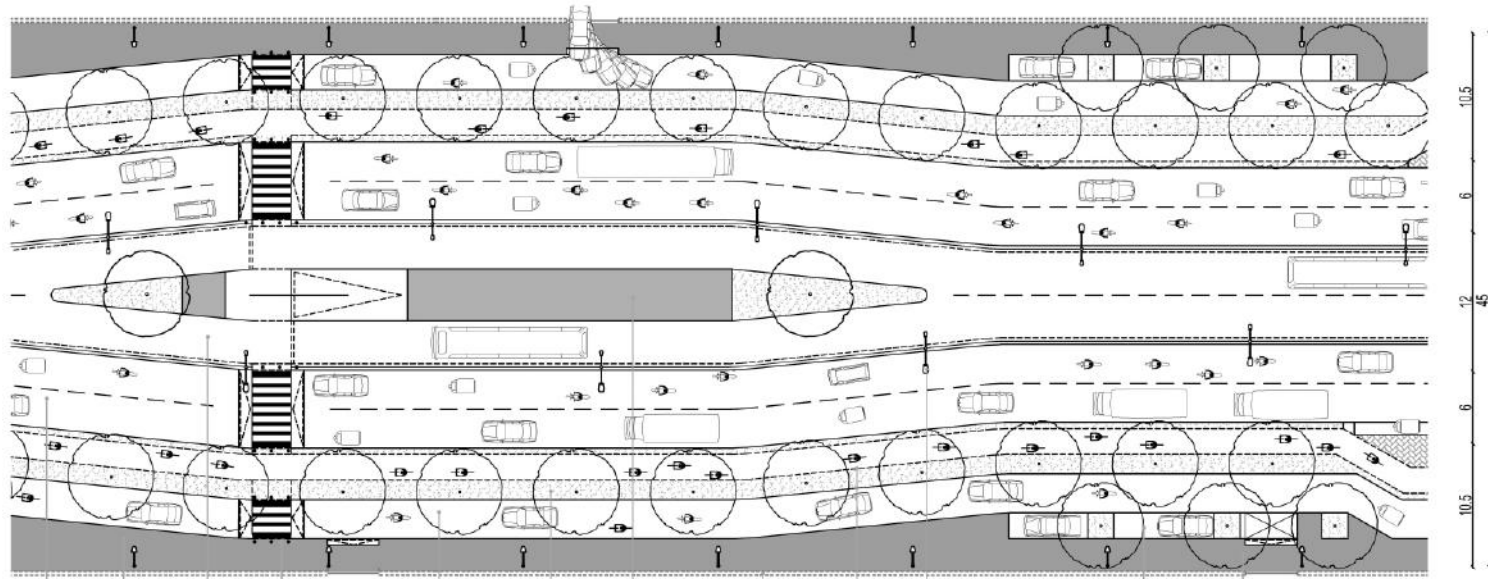

Carriage Way Asphalt Level ± 00 mm
 Footpath Paving Level +150 mm
 BRT Lane Asphalt Level +150 mm
 Raised Pedestrian Crossing Paving Level +150 mm
 Service lane Concrete Level ± 0.00 mm
 Tree Line Soil Level +150 mm
 BRT Station Level +1250
 Private Property
 Bicycle Track Concrete Level +150 mm
 Street Light
 Street Vending
 Parallel Parking Paving Level +50 mm
 Property Access
Plan of BRT Station

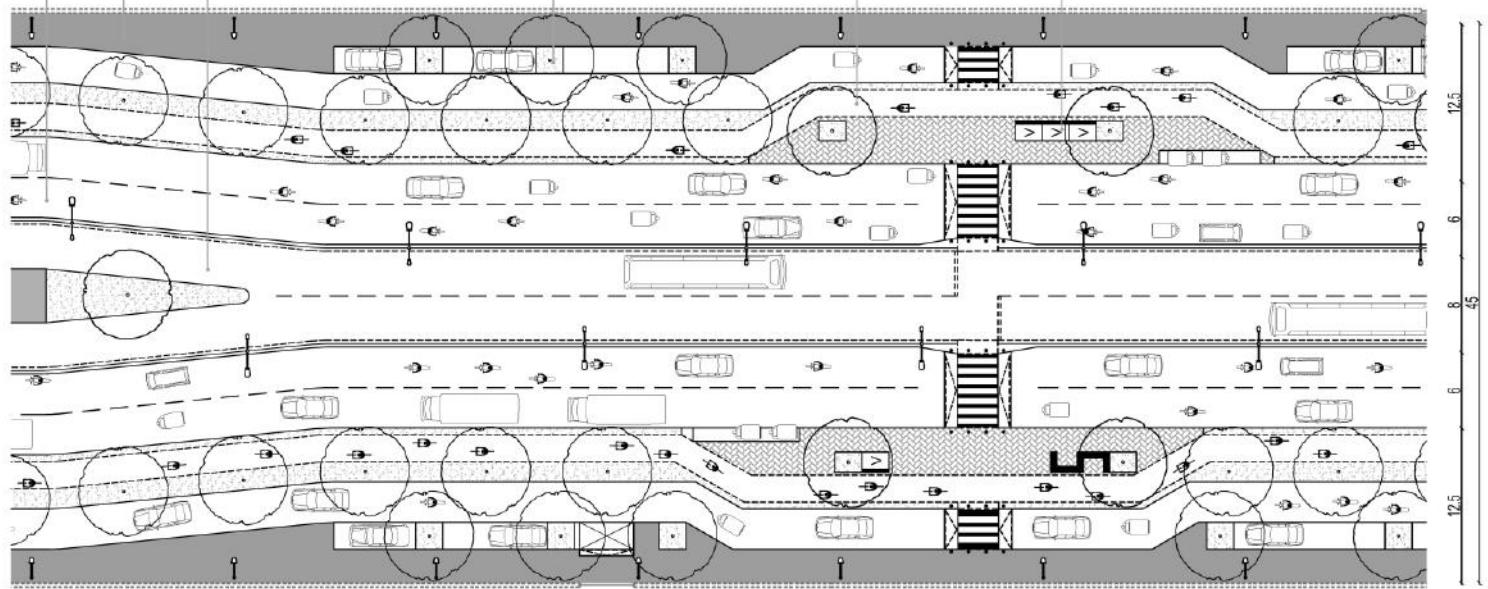

Plan of BRT lane

45 MTS. RIGHT OF WAY- BRT

Recommended for mobility corridors with through traffic

45 BRT

Elements of Street	Type/Composition	Surrounding Land use/Activity
Footpath	Both Side	Residential Neighbourhood
Cycle Track	Both Side	Commercial
Carriageway	Two Way, Divided, Central BRT lane	Institutional
Parallel Parking	Yes	Special Streets
Street Vending	Low Demand	Through Traffic (Mobility Corridor)

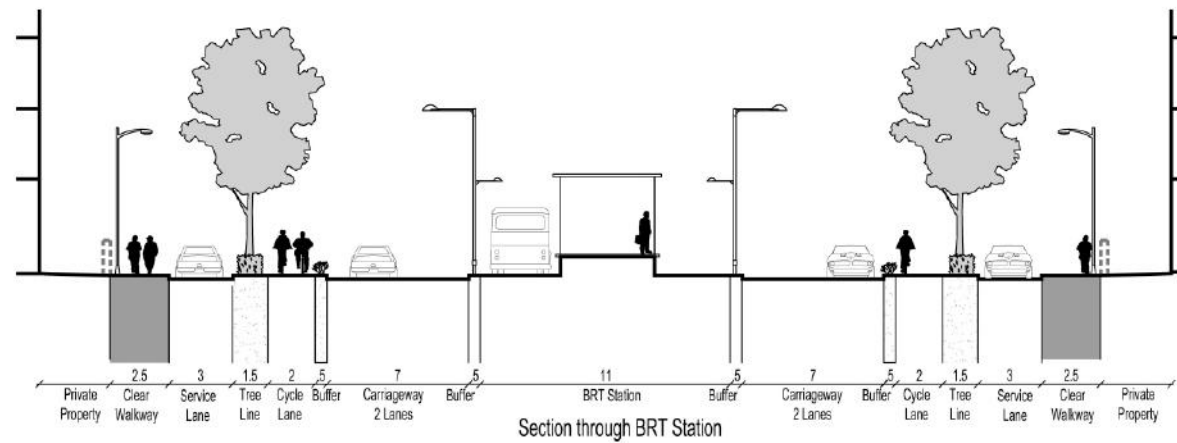
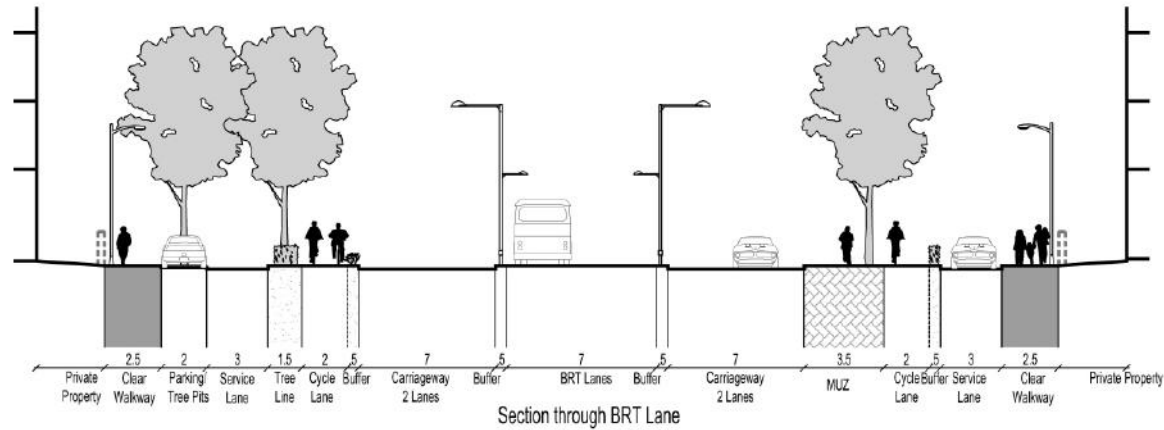

60 BRT

60 MTS. RIGHT OF WAY- BRT

Recommended for mobility corridors with through traffic

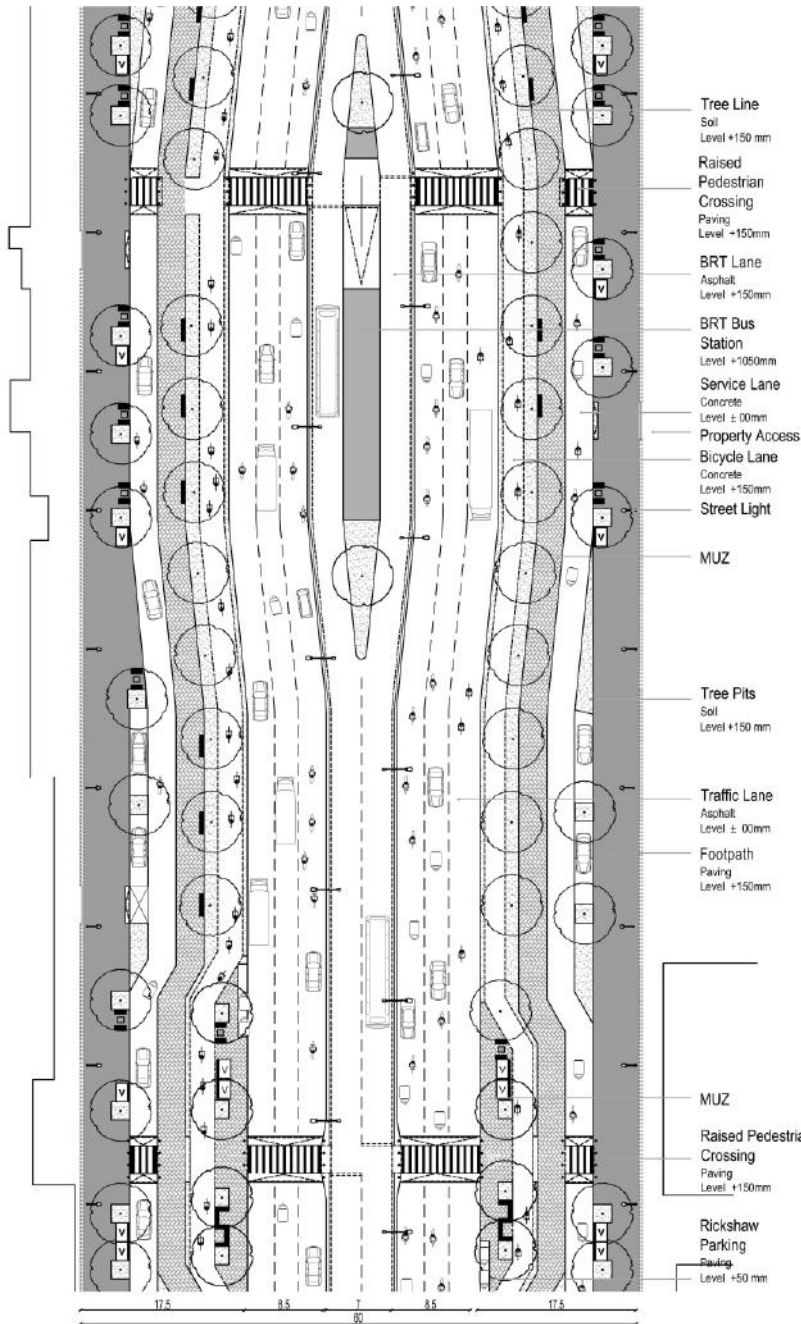

Elements of Street	Type/Composition	Surrounding Land use/Activity
Footpath	Both Side	Residential Neighbourhood
Cycle Track	Both Side	Commercial
Carriageway	Two Way, Divided, Central BRT lane	Institutional
Parallel Parking	Yes	Special Streets
Street Vending	Low Demand	Through Traffic (Mobility Corridor)

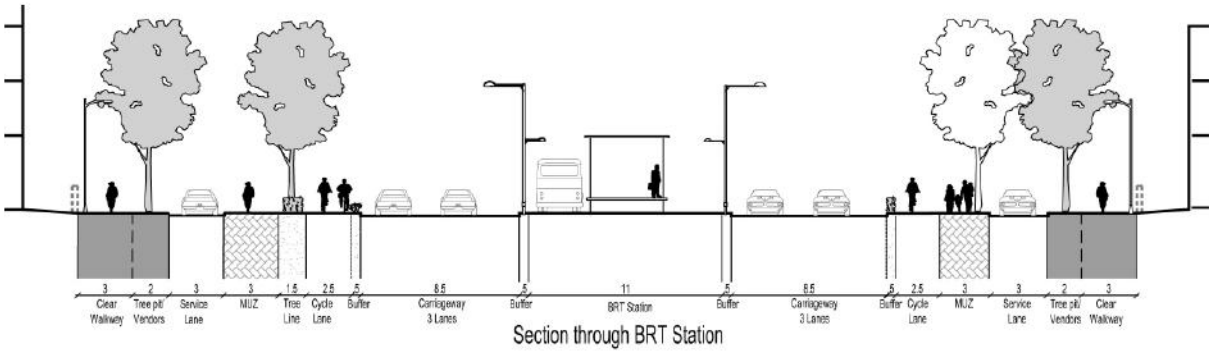
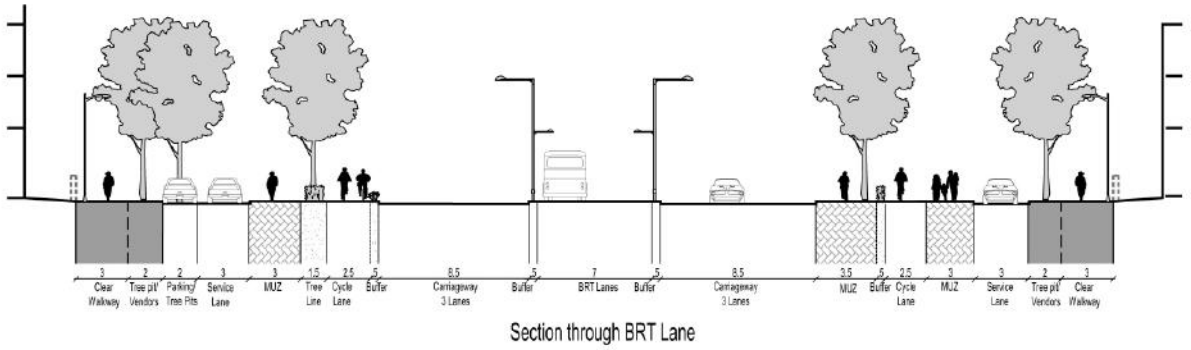

Intersections

**Intersection
12 m x 12 m
Roundabout**

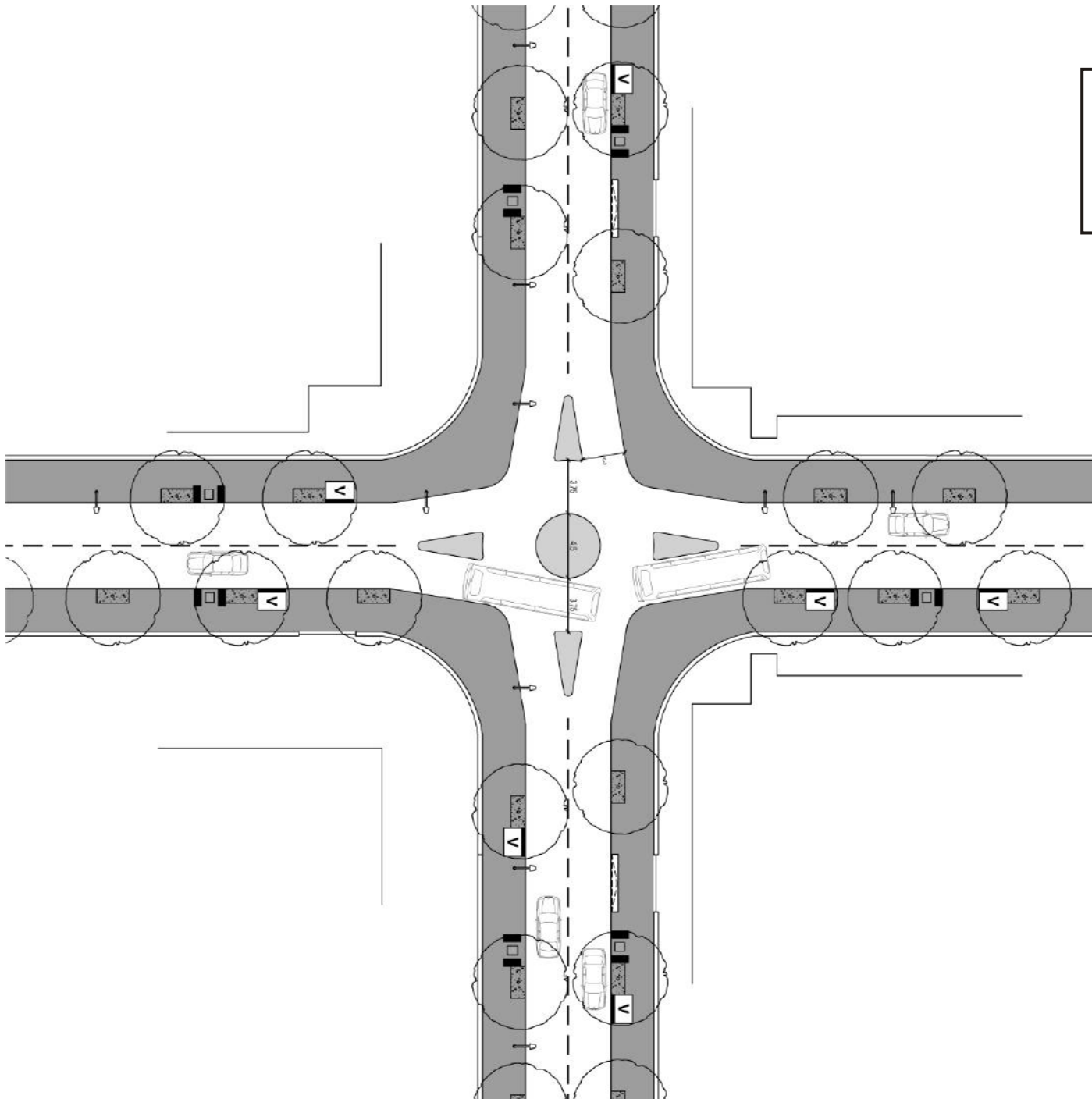

**Intersection
12 m x 12 m**

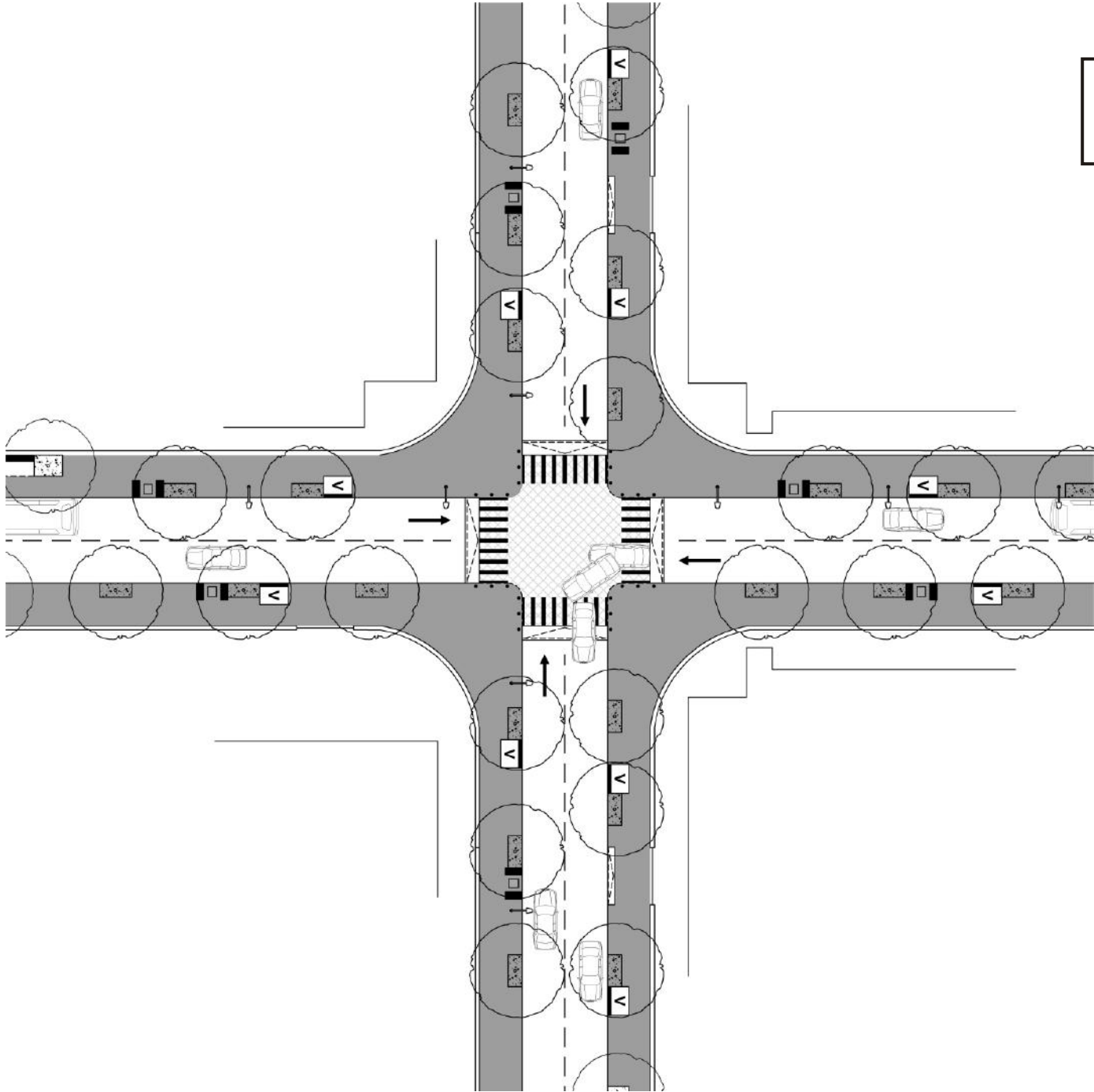

**Intersection
18 m x 18 m**

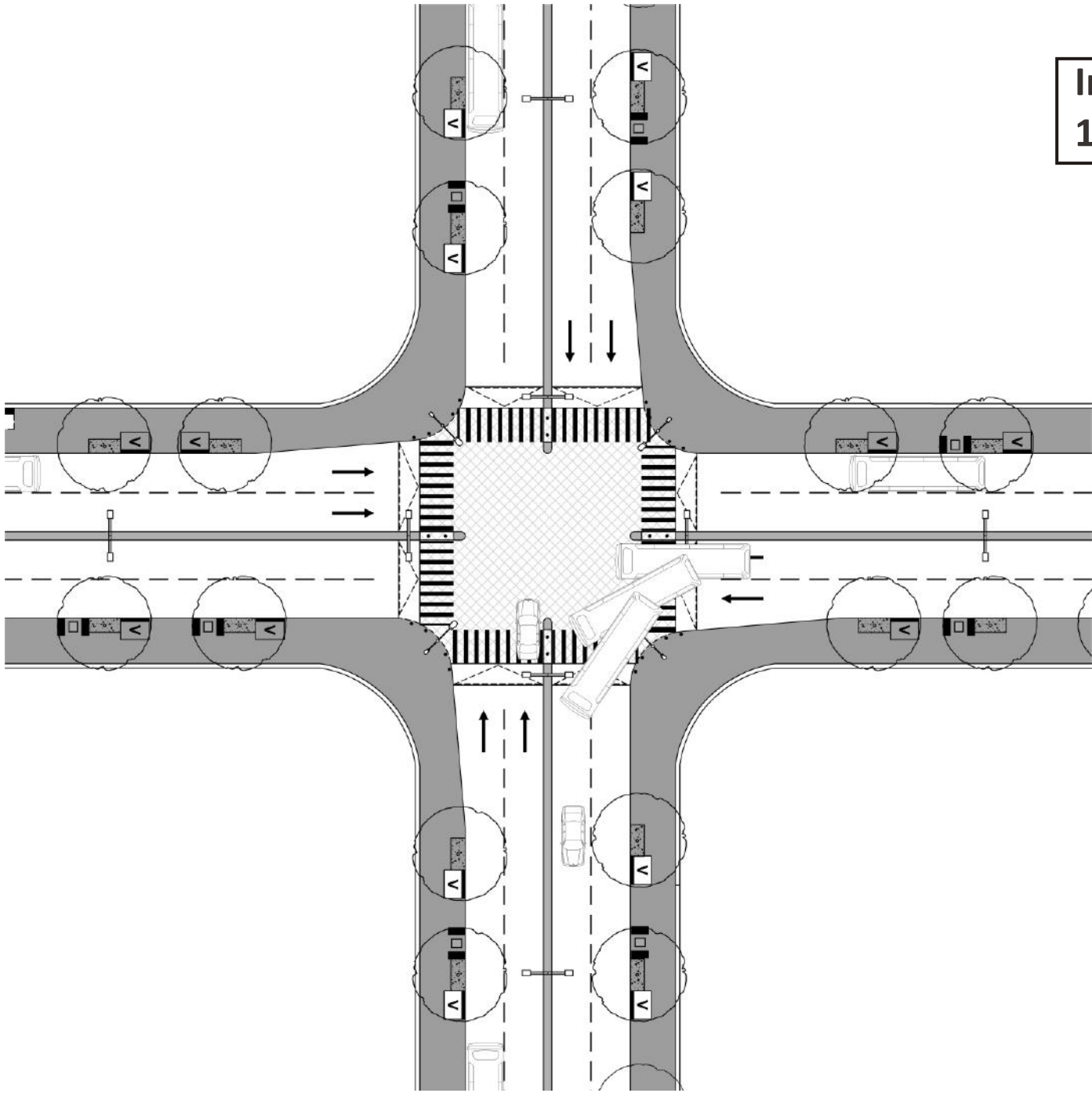

**Intersection
24 m x 24 m**

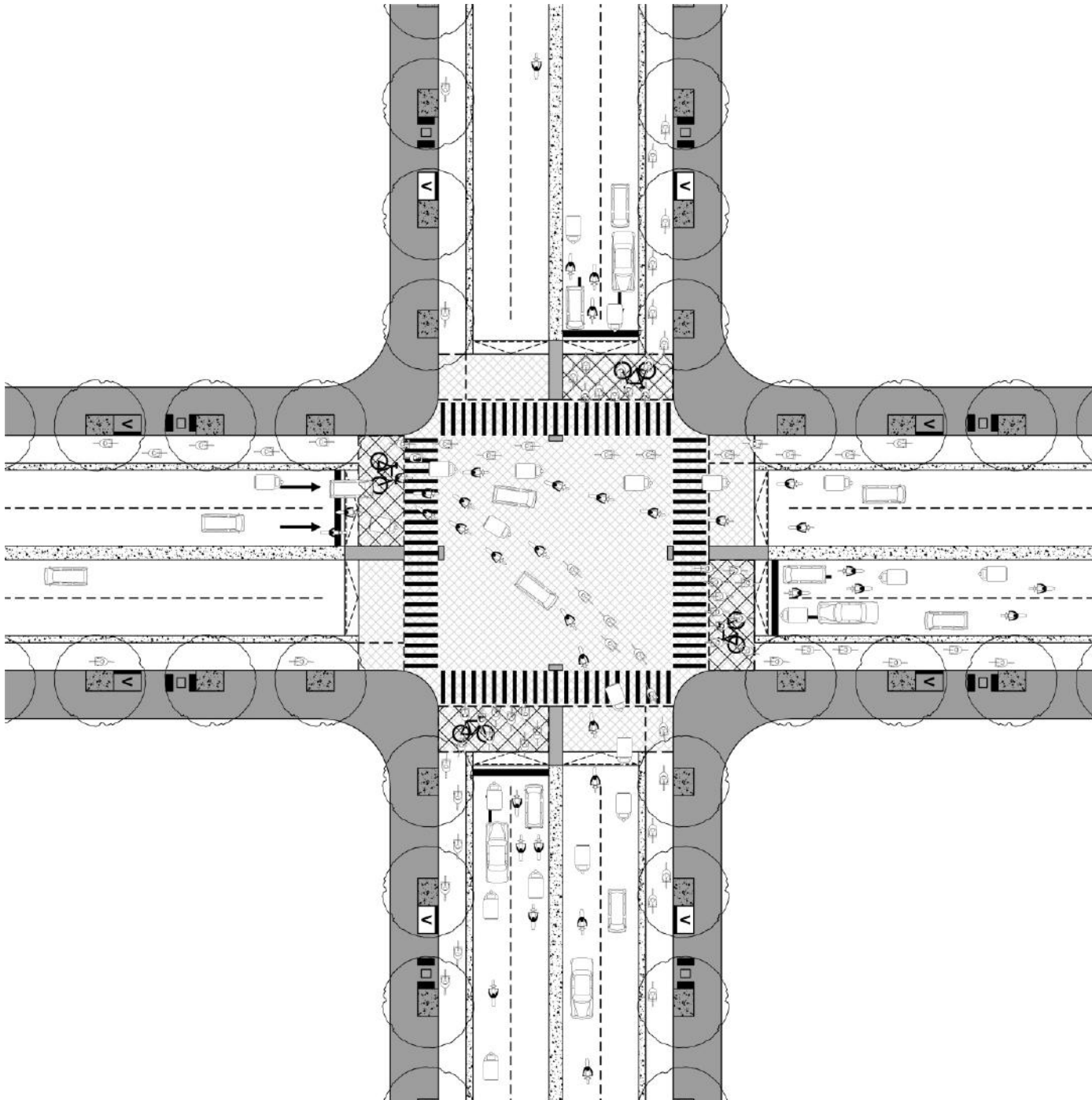

**Intersection
30 m x 36 m**

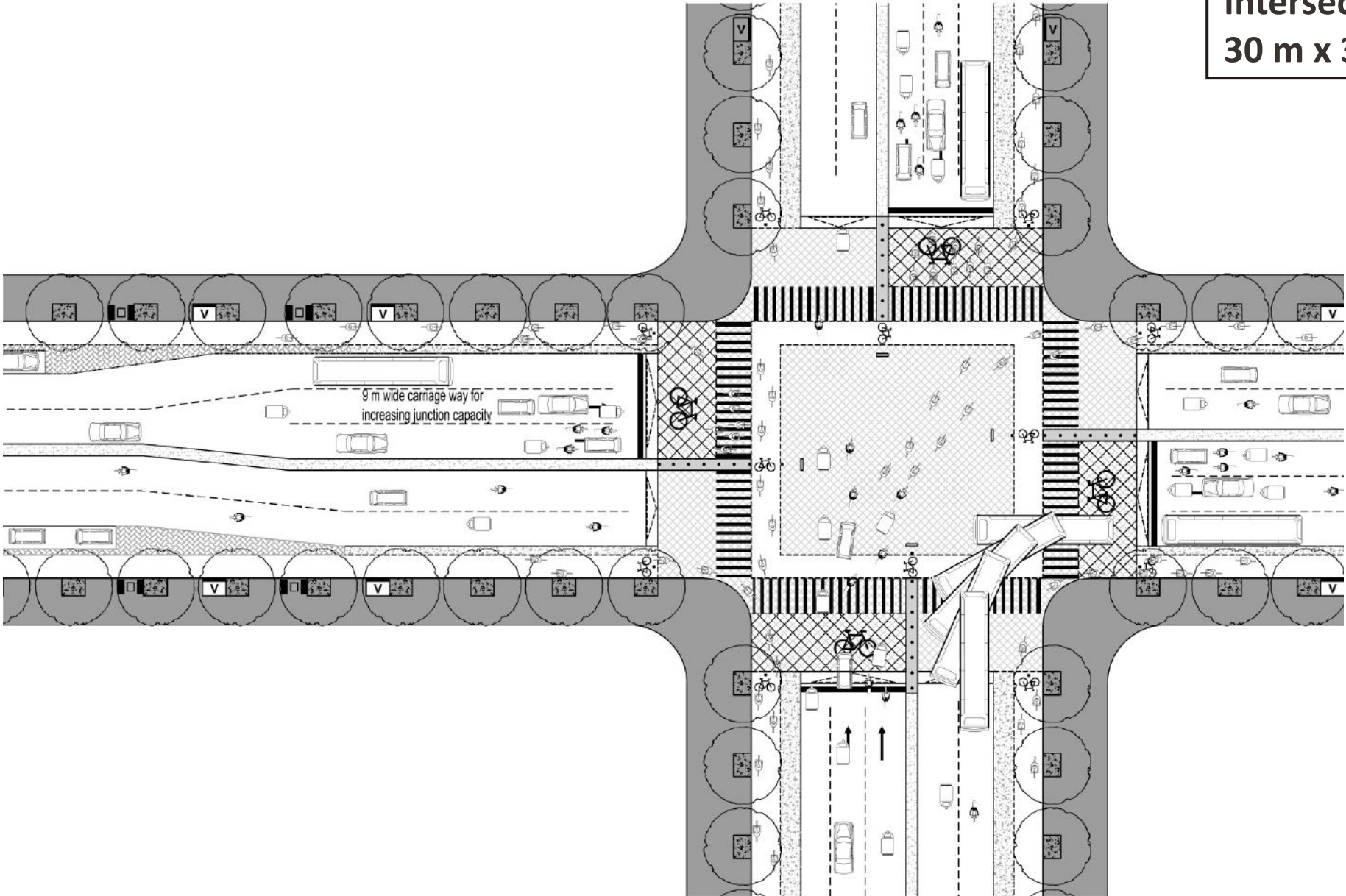

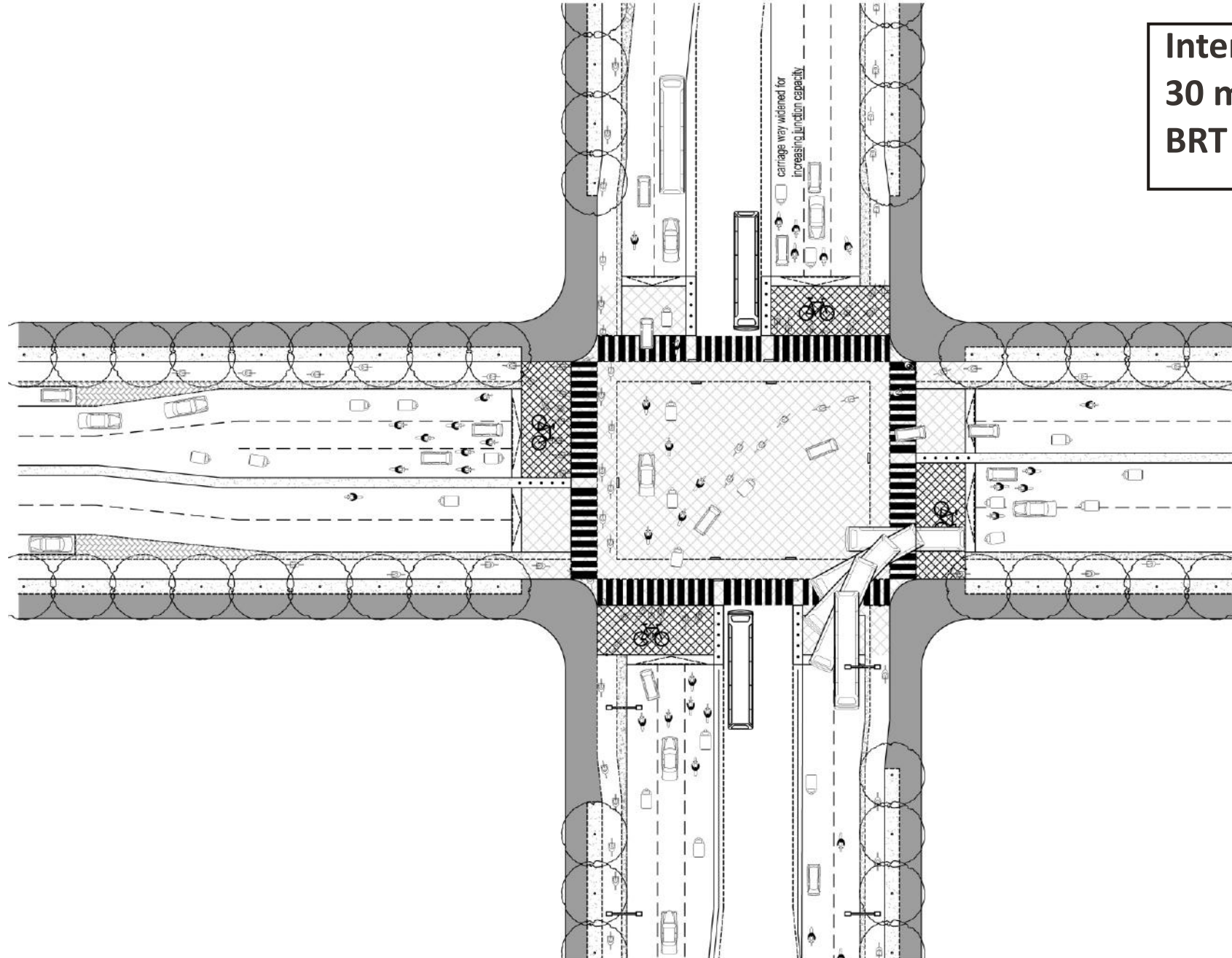

**Intersection
30 m x 36 m
BRT**

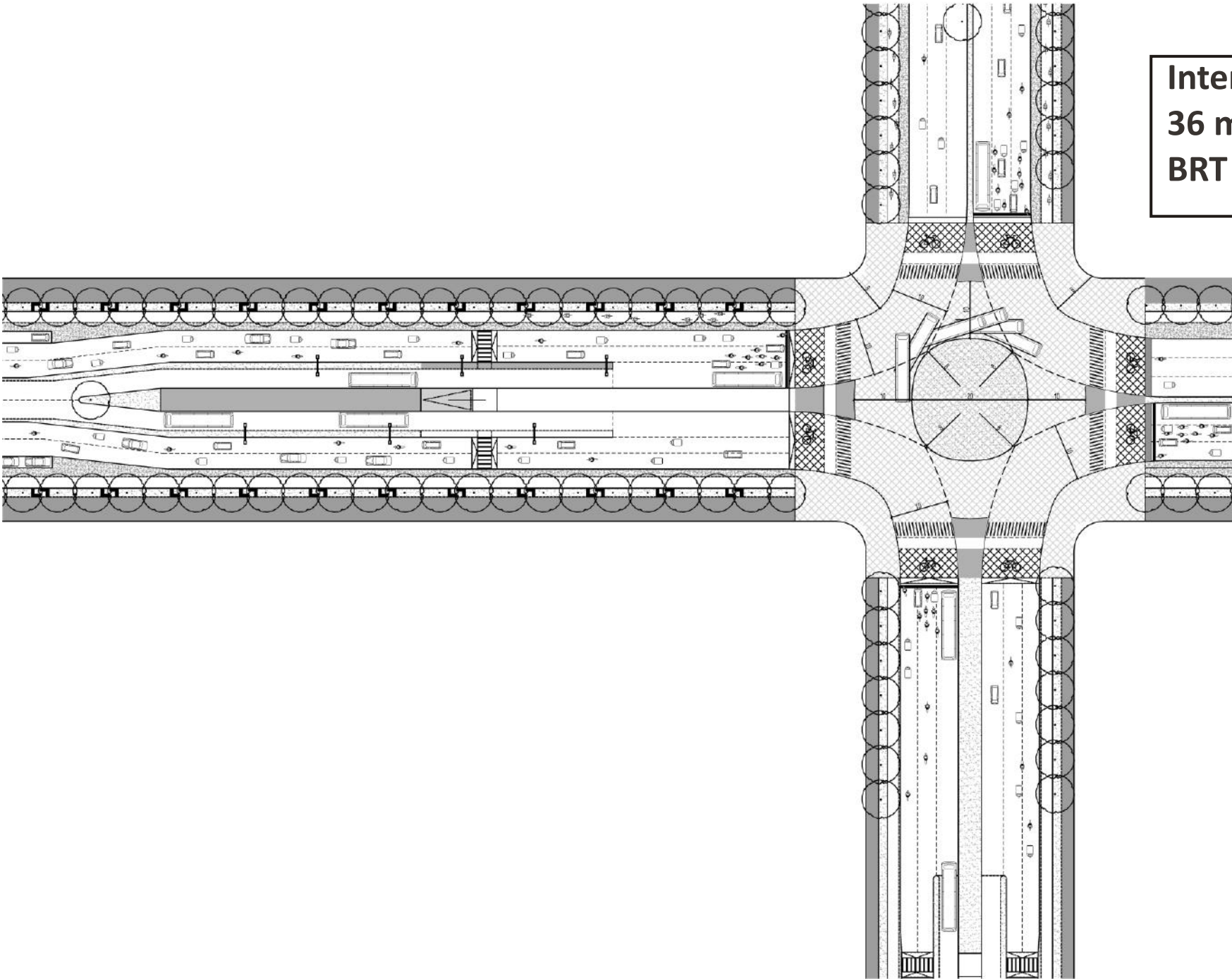

**Intersection
36 m x 42 m
BRT**

Before

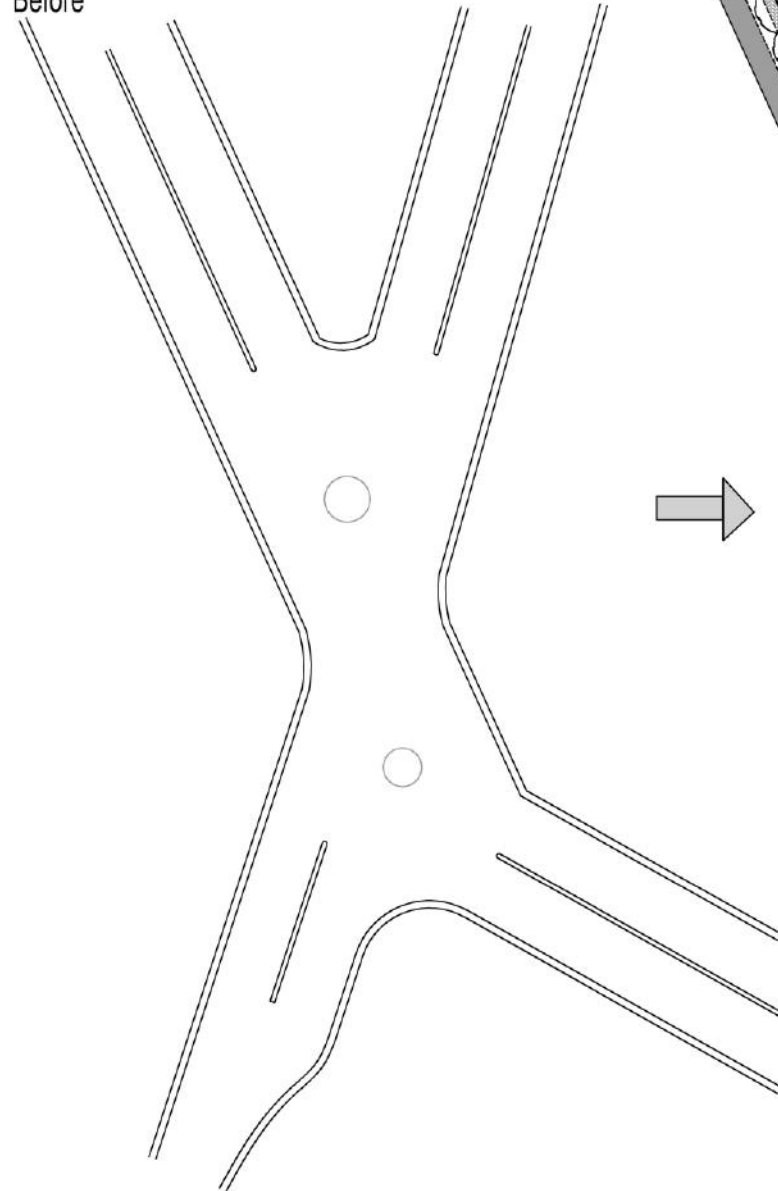

After

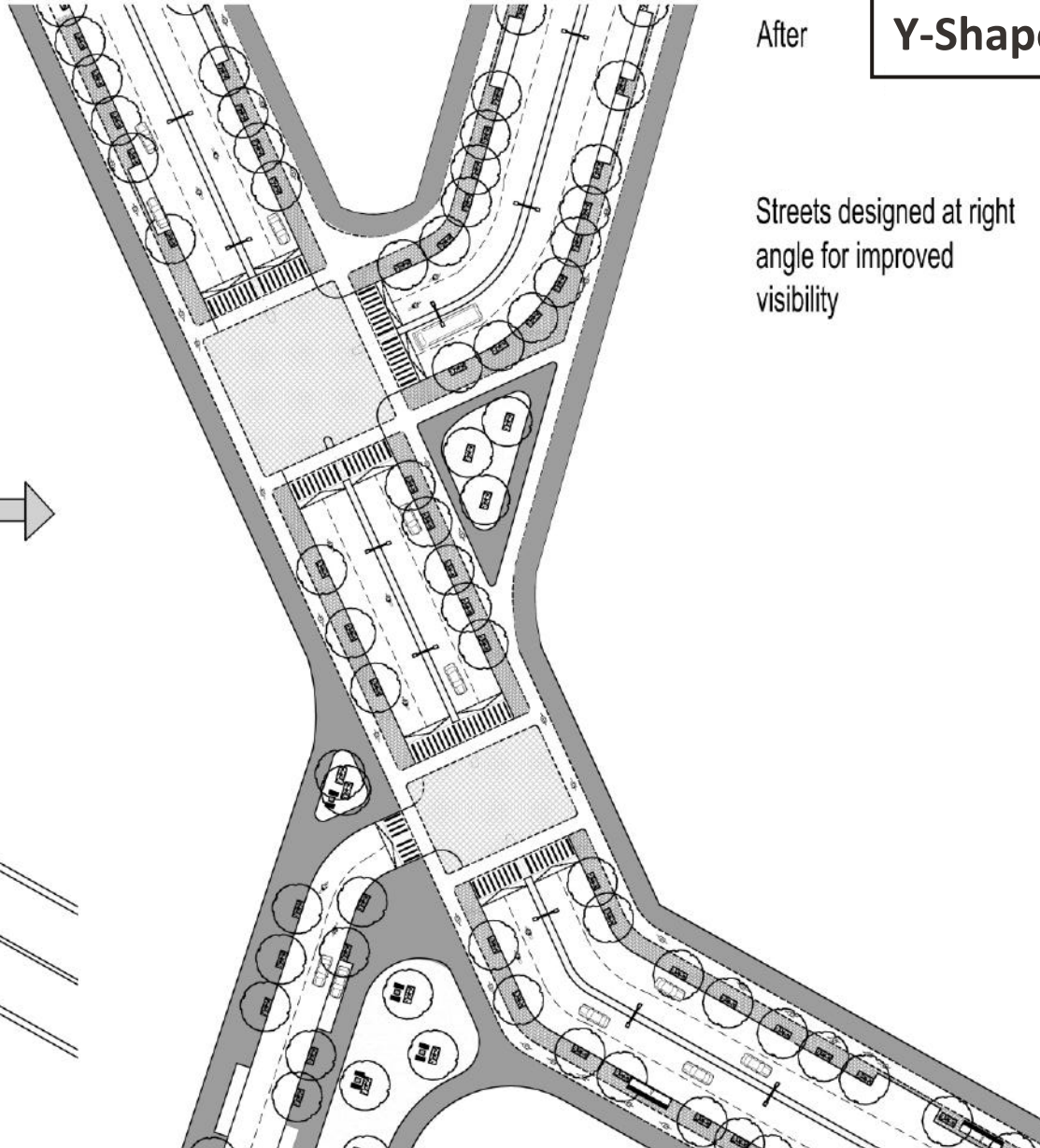

Intersection Y-Shaped

Streets designed at right angle for improved visibility



Street design process

Describes the methodology to be followed for any street related development work to achieve better and complete streets as envisaged in the vision of USDG.



09

PROCESS OF DESIGNING STREETS

USDG recommends that the designing of any street in Pune should follow a systematic process having logical and technical approach.

Following are the important stages of the street designing process for achieving the desired results:

1. Road inventory
2. Analysing activity survey information
3. Analysing traffic behaviour
4. Setting up vision for the street
5. Selecting appropriate USDG template for designing the street
6. Right of way overlay
7. Junction design
8. Integration of existing elements
9. Stakeholder consultation at conceptual stage

Road inventory

The road inventory survey determines the location of natural and man-made physical features, such as buildings and immovable street furniture.

The locations of the following objects should be noted in the survey:

1. All objects in the roadway (e.g. Religious structures, light/telephone/electric poles, traffic signals, medians, islands, footpaths, pavements, utility boxes, electric substations)
2. Compound walls (including private property gate locations and widths)
3. Footprints of structures (both kuccha and pucca) in the property abutting the public right-of-way, including plinth level, surface levels
4. Trees, differentiated by circumference (< 30 cm, > 30 cm)
5. Landscape details, such as the location, spread, and value of existing trees, shrubs, and green areas
6. Manholes, drains, and catch pits, culverts, open drains, and bridges
7. HT lines, water pipelines, drainage lines
8. Building names for reference

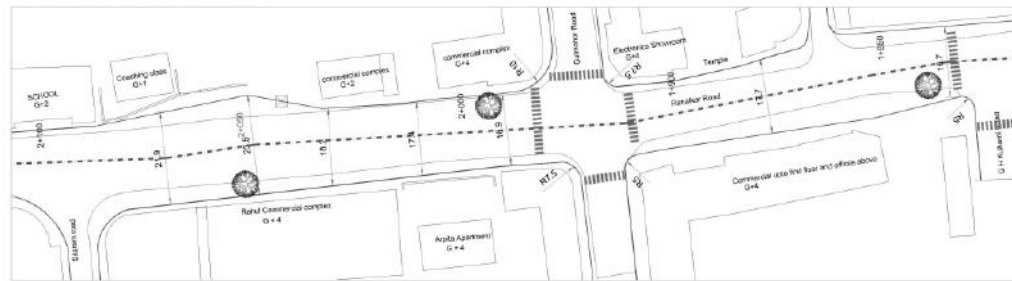

Analyse activity survey information and traffic behaviour

Pedestrian and activity surveys inform the selection of pedestrian and livability elements and the design of traffic calming features and intersections.

A pedestrian survey maps pedestrian movements to inform the expansion or improvement of pedestrian facilities. It takes note of any obstacles, such as median fences and unsurmountable islands. Observation of pedestrian movements and destinations can inform the placement and design of formal crossings.

In cases where pedestrians are not using existing footpaths, the survey can map possible reasons, such as insufficient width or conflicts with other uses. The pedestrian survey also can identify locations where traffic calming is necessary to improve safety, particularly at junctions.

Activity mapping

An activity survey records the type and location of stationary activities, ranging from leisure activities, such as people-watching and games, to street vending. The stationary activity pattern can be recorded at hourly intervals. The locations of individual street vendors should be marked. Capacity and location of parking bays should be marked.

Following traffic surveys are required to assess the traffic characteristics of the study area-

1. Pedestrian and cyclists counts

2. Turning movement counts

3. Parking surveys (Number, type, orientation, and location of parked vehicles including auto rickshaws-both on street and off street)

4. Speed and delay

5. Bus passenger boarding alighting counts

6. Traffic volume counts- Vehicles should be counted during the peak period when traffic volumes and space requirements are highest. Counts can be conducted on site or from a video recording. The count should be classified by vehicle type. For a manual survey of a typical signalized four-way intersection, one surveyor can stand at each arm, counting the incoming traffic.

2. Analyse activity survey information

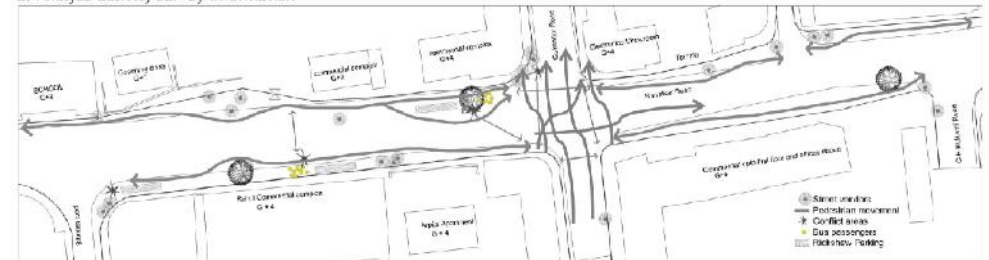

The traffic survey records vehicle types separately. However, for analysis of the overall capacity of an intersection, the vehicle counts are converted into passenger car units (PCUs) that express the space occupied by each vehicle as a fraction of the space occupied by a typical passenger car. This way, the counts are expressed in a uniform unit and can be summed to determine a single value for the overall traffic volume. The PCU values can be used in capacity and signal timing calculations. The PCU counts should be converted into occupancy analysis based on which the junctions and streets should be designed. Eg. The graph below shows that the buses carry more people than cars and two wheelers and hence need more road space.

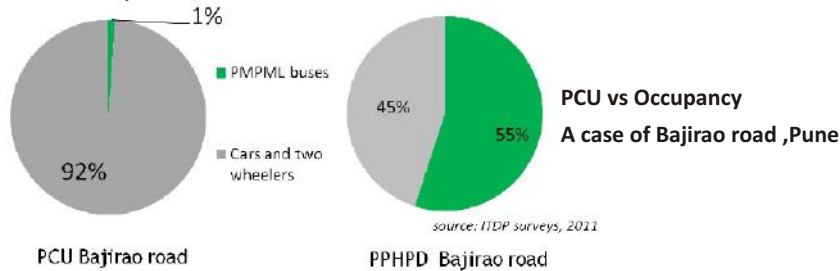

By allocating dedicated spaces for street vending and by providing street furniture to complement the vending activities and to give people a place to sit, relax, interact, and people-watch, providing high quality spaces for walking and promoting sustainable modes of transport through designing.

Choosing a standard USDG template

After setting up the vision or concept for any street design project, urban street design guidelines should be referred at every stage from all aspects while working out the design from conceptual level to detail design proposal.

The template should be chosen based on the surrounding landuse of that area and requirement of different street features such as footpath, cycle track, availability of parking, requirement of vending zones etc as per the set vision.

Right of way overlay

When defining the right-of-way, one should not take for granted that all encroachments can be removed. Instead, unless the encroachment can be removed before designs are finalized, the designer should attempt to accommodate the encroachments within the street design or define the right-of-way such that potential encroachments lie outside the right-of-way.

The centre line implied by a right-of-way should not be confused with the built median. The previous street design may have been asymmetrical or simply inexact, so the final design should work from the centre line defined by the new right-of-way rather than from any built features alone.

3. Analyse traffic behaviour



Setting up vision for the street

No.	Key observations	Vision
1	Discontinuous, encroached footpaths, high pedestrian footfalls because of commercial activities	Wide footpath
2	Poor safety of school children	Provision of cycle track
3	Encroachment by street vendors on footpaths	Provision of street vending bays adjoining footpath

To initiate the design process, it is helpful to brainstorm possibilities that the site holds for creating a more comfortable, people-friendly environment.

The new design can recognize the variety of activities already happening in the public realm

5. Define center line. Select the cross section of the lowest ROW. In this case it is 15m

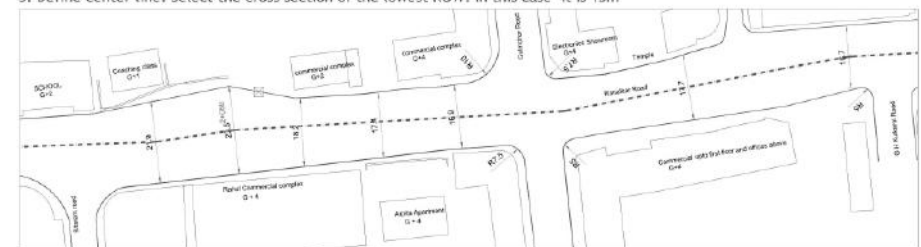

6. Define cross section. Accommodate additional space in footpaths wherever ROW is greater than 15m

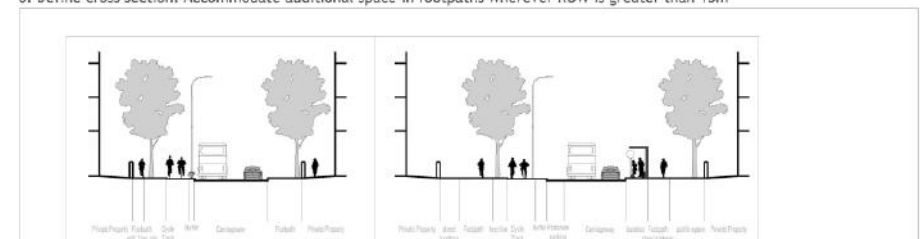

Right of way overlay

After defining center line of the right of way, carriageway should be designed such that its width remains constant through out. This will help in avoiding the bottlenecks. The remaining width of the ROW should be designed for NMT spaces.

7. Keep motorvehicle lane width constant. Design non motorised transport spaces in remaining width.

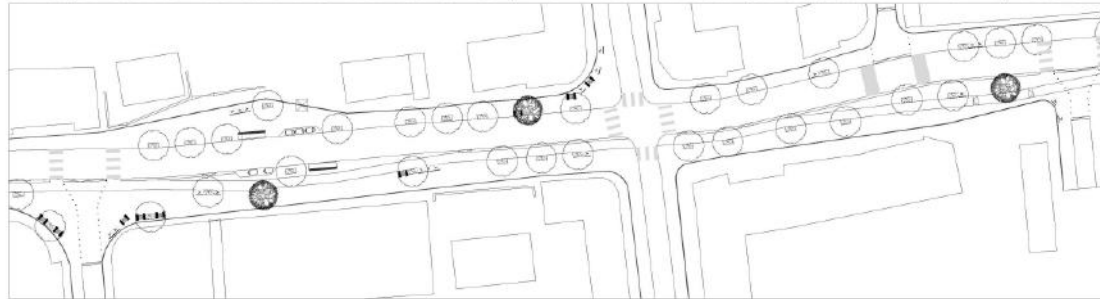

Stakeholder consultation

The authorities and decision makers should take initiative to invite suggestions from people and elected representatives as the conceptual design stage is initiated.

Suggestions and views of following stakeholders should be invited on designs:

- PMCRoad engineers
- Traffic police
- PMPML
- Local elected representatives
- Trees authority
- MSEDCL (electric supply co.)
- Local NGOs and environmentalists
- Experts

Intersection design and integrating existing elements

After setting of vision and referring to urban street design guidelines and taking cognizance of surveys and observations, the design of street has to be initiated. Adjoining intersections need to be made compact by designing tight turning radius, thereby making the intersections safer for pedestrians and cyclists.

Existing trees should be properly integrated in the design. Elements required for universal access should be integrated in the design. Hawkers, bus stops, parking should be considered.

Design should be such that it is flexible as regards allocation of spaces based on future proposals.

8. Ensure that the junctions are compact. Design to accommodate existing trees, temples etc. Design parking bays

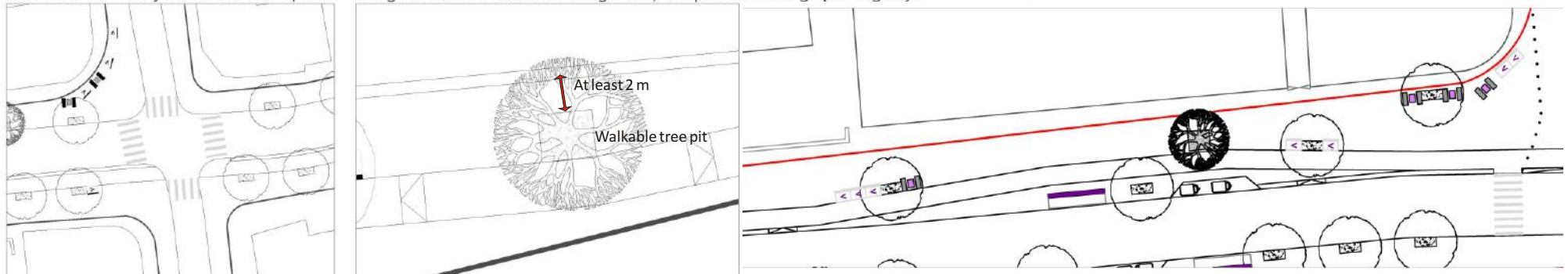

Pune Municipal Corporation

2016